



TABLE OF CONTENTS

FIBERGLASS DOORS SPECIFICATIONS OVERVIEW

Features	04
Build Type Options	05
Edge Prep Details	06
Hardware Locations	09
Embossment Profiles	10

SOLID FLUSH

6'8" Doors	12
6'8" Sidelights	13
7'0" Doors	15
8'0" Doors	16
8'0" Sidelights	17

ESTATE

6'8" Doors	20
6'8" Sidelights	30
7'0" Doors	32
8'0" Doors	34
8'0" Sidelights	37

SHAKER

6'8" Doors	40
6'8" Sidelights	42
8'0" Doors	43
8'0" Sidelights	45

CONTEMPORARY

6'8" Doors	47
8'0" Doors	55

PRO OAK

6'8" Doors	64
6'8" Sidelights	69

CLASSIC FLUSH GLAZED

6'8" Doors	71
6'8" Sidelights	73
8'0" Doors	74
8'0" Sidelights	76

ESTATE FLUSH GLAZED

6'8" Doors	78
6'8" Sidelights	80
8'0" Doors	81
8'0" Sidelights	82

SHAKER FLUSH GLAZED

6'8" Doors	84
6'8" Sidelights	87
8'0" Doors	89
8'0" Sidelights	90

STEEL DOORS SPECIFICATIONS OVERVIEW

Features	
Wood Edge	92
Steel Edge	93
Edge Prep Details	94
Hardware Locations	95
Embossment Profiles	96

STEEL MARK & STEEL MARK PLUS

6'8" Door	98
6'8" Sidelight	110
7'0" Door	118
7'0" Sidelight	122
8'0" Door	123
8'0" Sidelight	128

STEEL PRO

6'8" Doors	130
------------	-----

ADDITIONAL RESOURCES

Fire Rated Options	134
ADA Options	136
Fiberglass Door Accessories	
SDL Kits	137
Dentil Shelves	138
Cleaning and Finishing Instructions	139
Steel-Edge Adjustable Hinge Instructions	141

FIBERGLASS DOORS

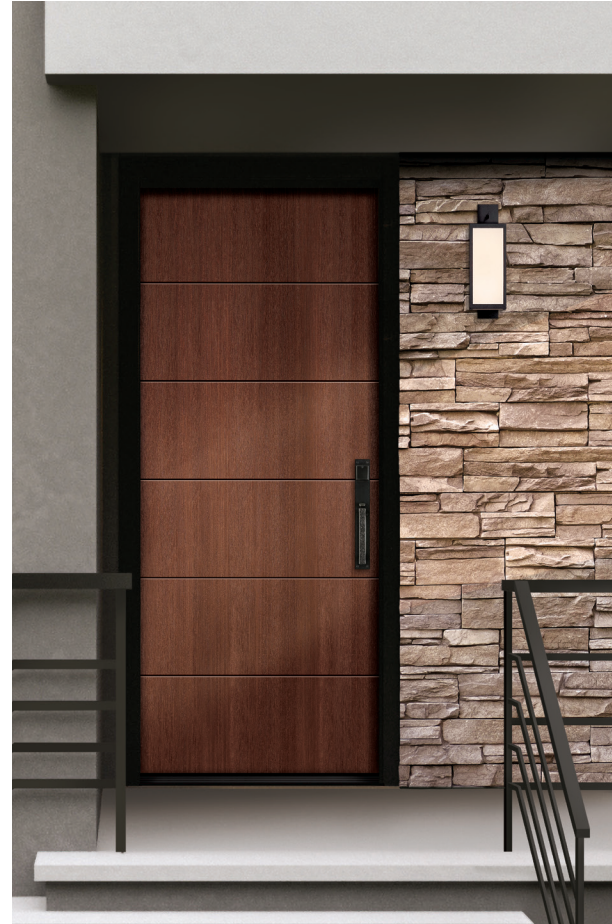

FEATURES

FIBERGLASS DOORS

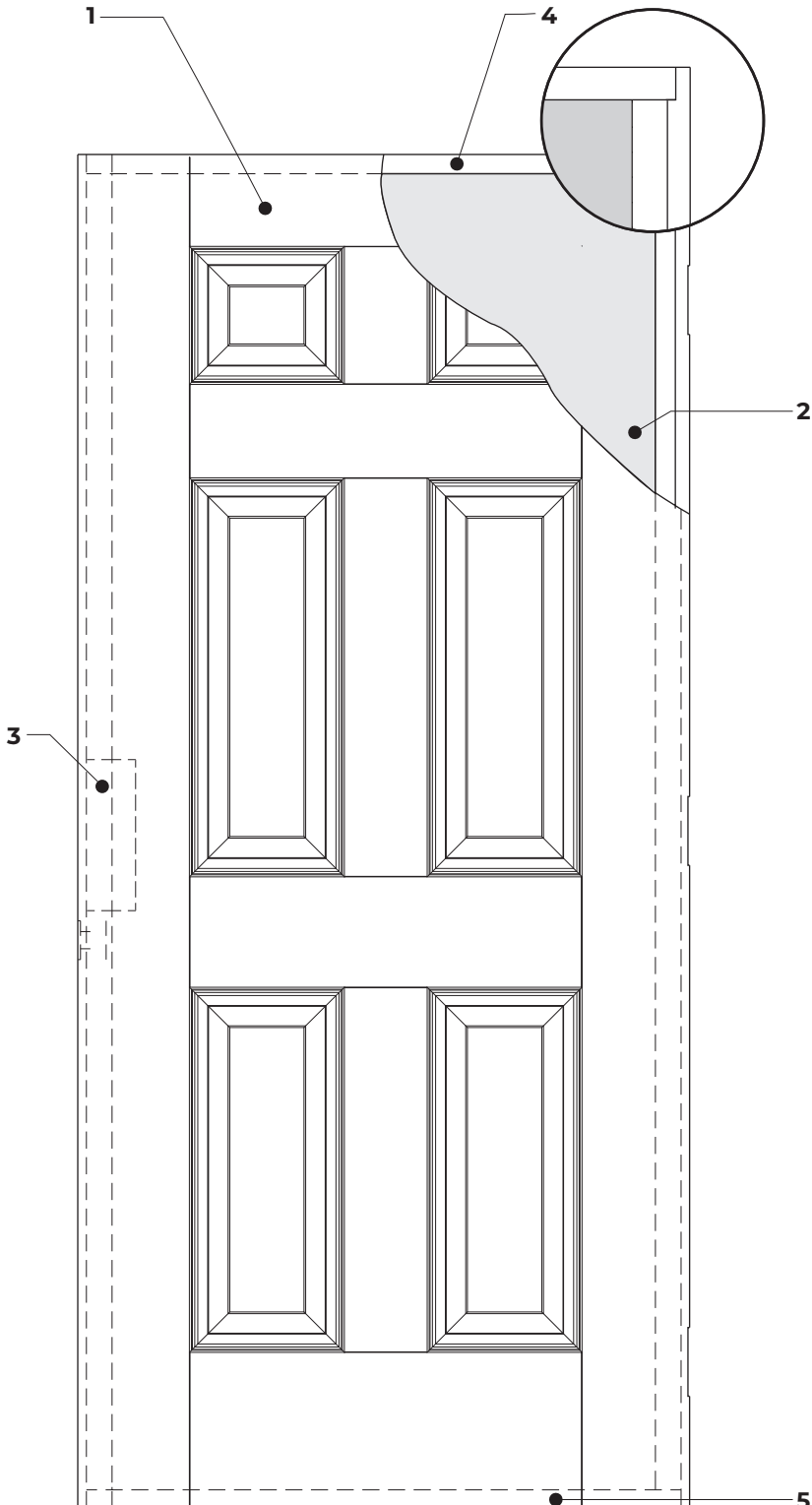

1.0 FIBERGLASS SKINS

- 1.1 Fine Grain | Tan
- 1.2 Rift Cut | Tan
- 1.3 Satin Smooth | White

2.0 FOAM CORE

- 2.1 Material: Polyurethane
- 2.2 Density: 2.2 lbs/cu.ft

3.0 SIDE STILES

- 3.1 Material: LVL w/Composite PVC cap
- 3.2 Pine lock block

4.0 TOP RAIL

- 4.1 Material: Composite

5.0 BOTTOM RAIL

- 5.1 Material: Composite
- 5.2 Kerfed for drive in sweep

PACKAGING

- Doors per pallet: 27
- SideLights per pallet: 30
- Banding: Metal (x2)
- Other: Corner boards (x4)
- Polyfilm wrap
- Product identification all four sides
- Four way access pallet

STANDARD FEATURES

- Hinge prep
- Cylindrical lock locations
- Square edge design
- 1 3/4" door width

BUILD TYPE OPTIONS

FIBERGLASS DOORS

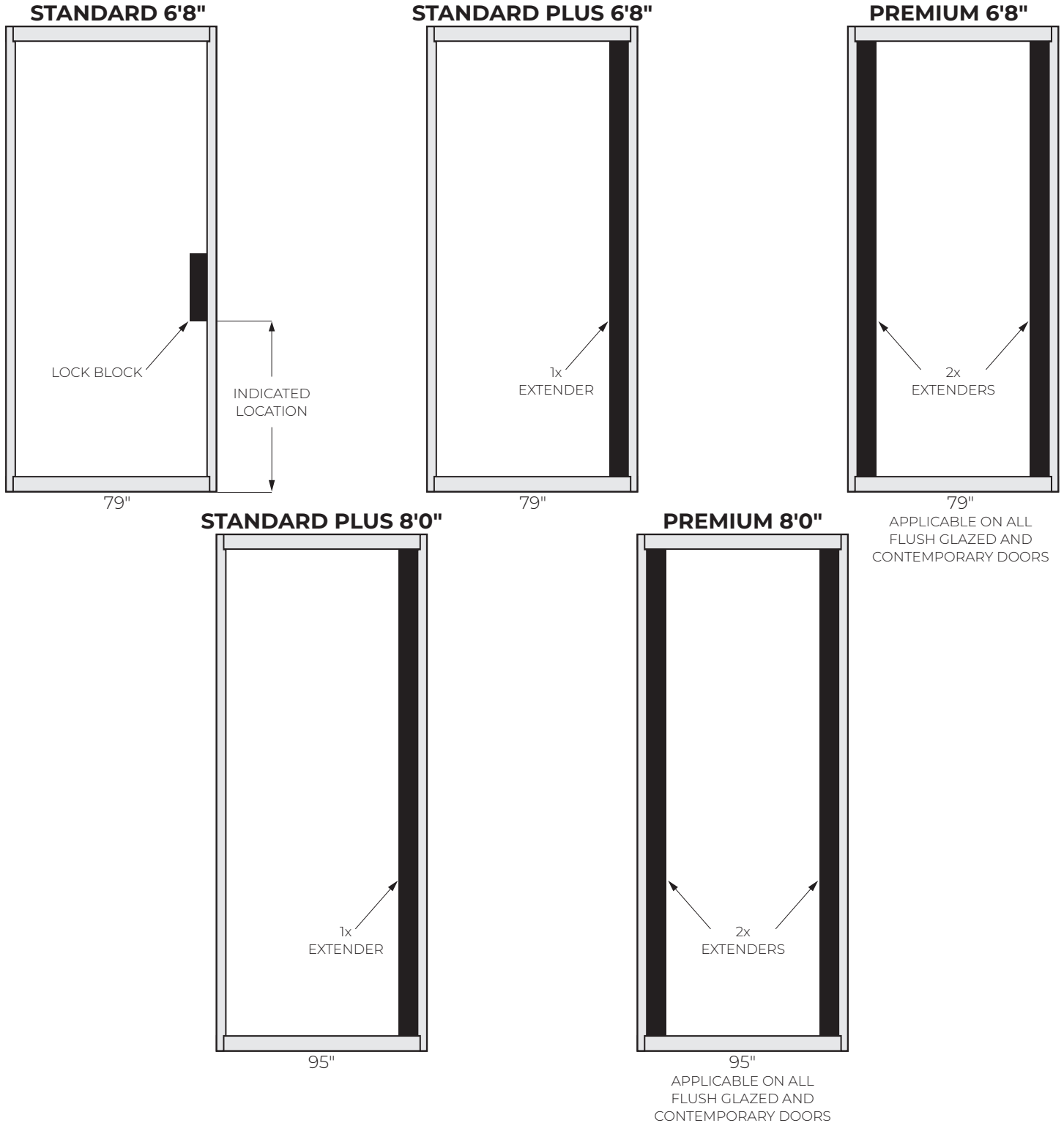

EDGE PREP DETAILS

FIBERGLASS DOORS-STANDARD BUILD

LATCH PREP

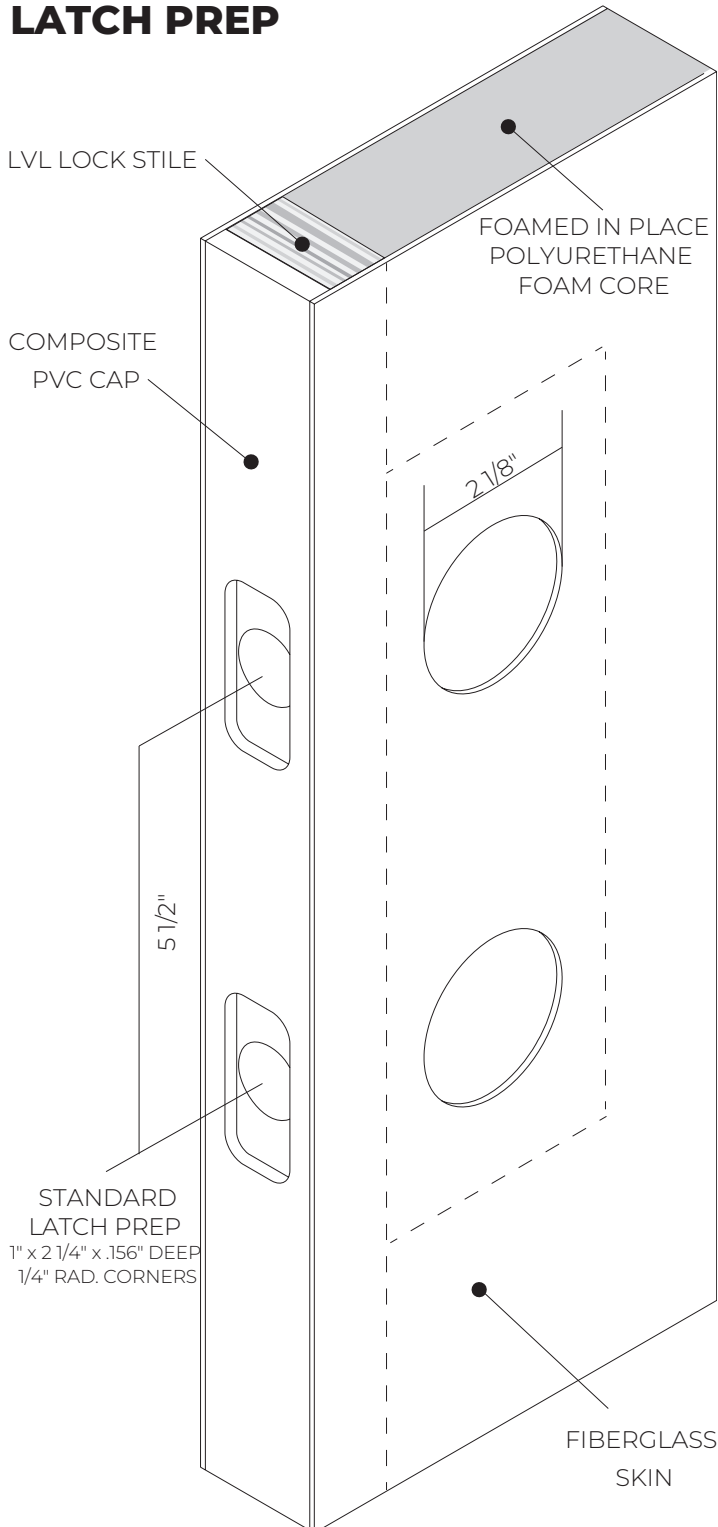

HINGE PREP

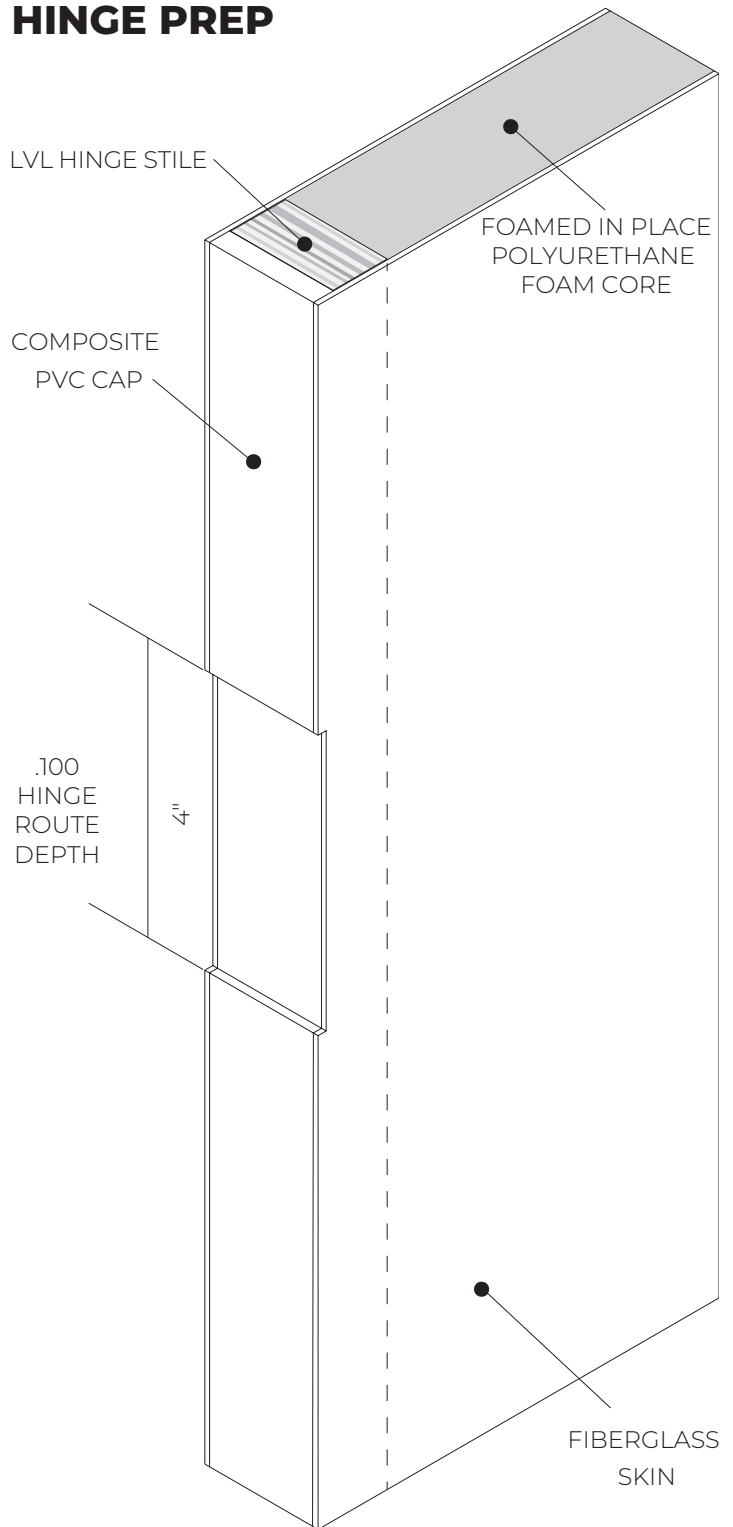

EDGE PREP DETAILS

FIBERGLASS DOORS-STANDARD PLUS BUILD

LATCH PREP

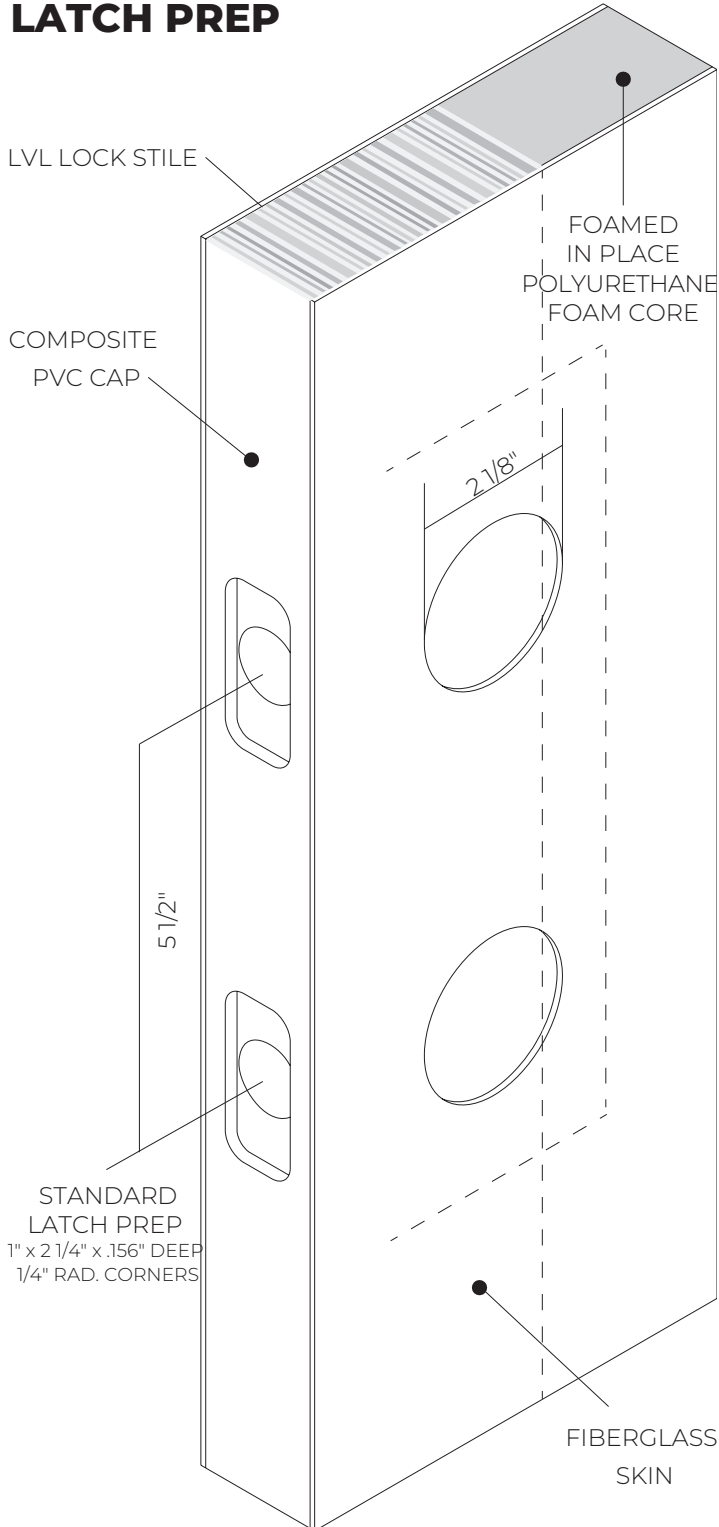

HINGE PREP

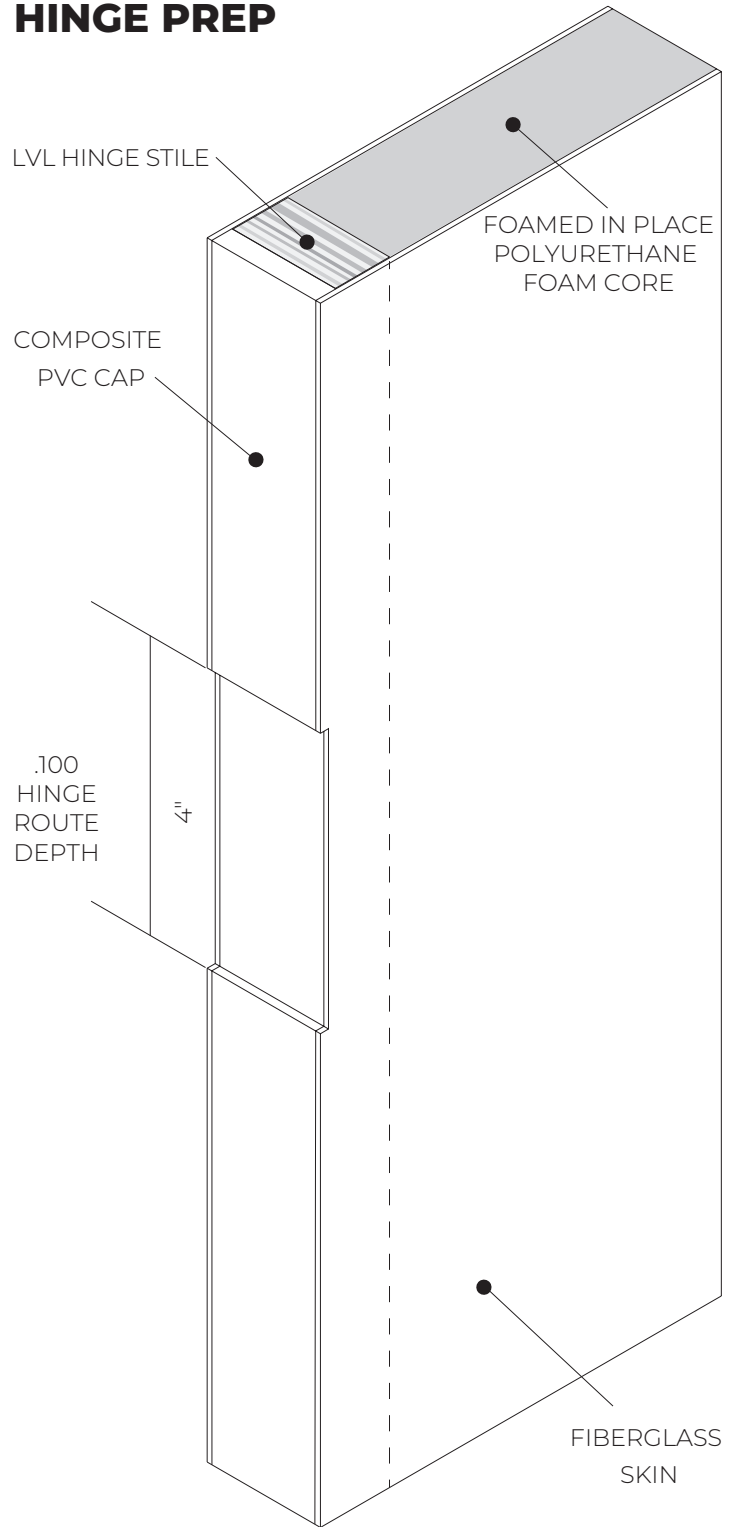

EDGE PREP DETAILS

FIBERGLASS DOORS-PREMIUM BUILD

LATCH PREP

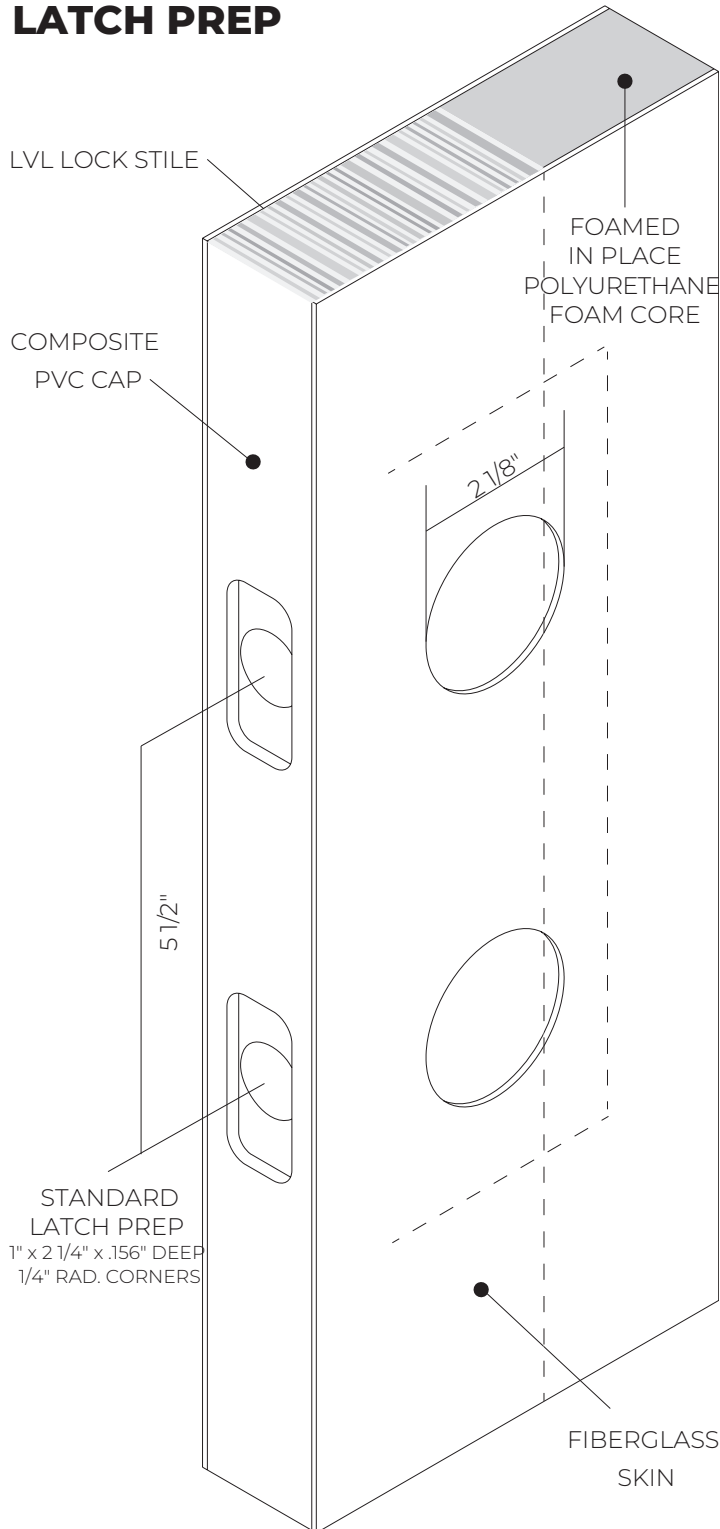

HINGE PREP

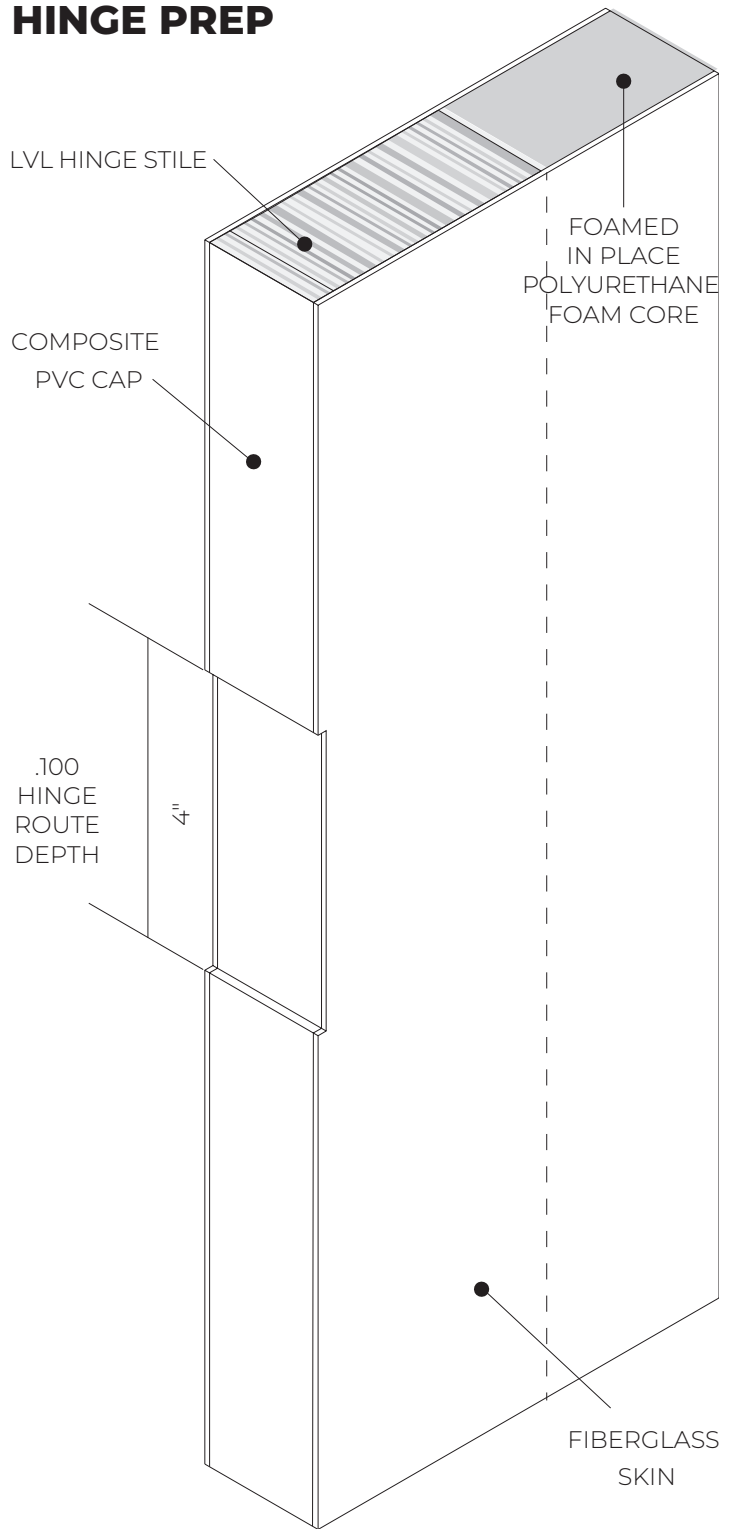

HARDWARE LOCATIONS

FOR SMOOTH AND TEXTURED FIBERGLASS DOORS

6'8" LOCATIONS

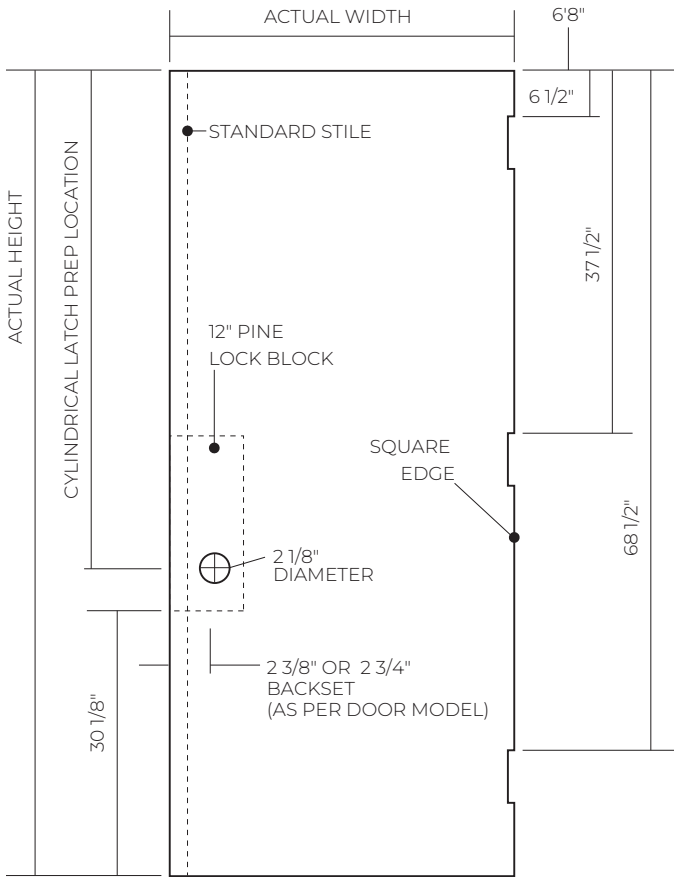

8'0" LOCATIONS

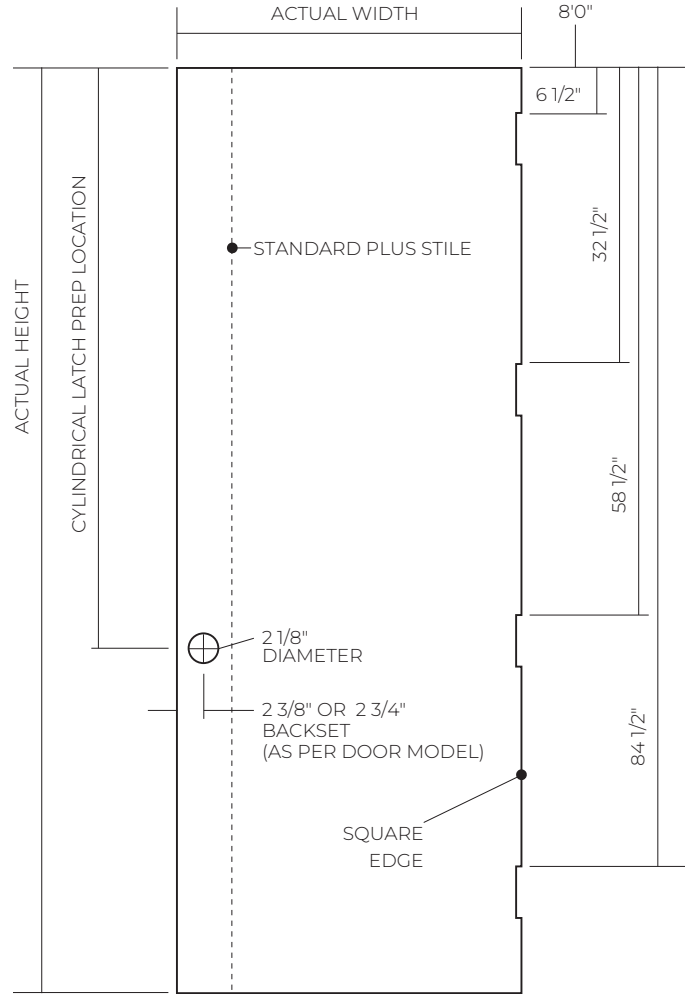

DOOR HEIGHT		
NOMINAL	ACTUAL	CYLINDRICAL LATCH PREP LOCATION
6-8	79"	45 7/8"

DOOR HEIGHT		
NOMINAL	ACTUAL	CYLINDRICAL LATCH PREP LOCATION
8-0	95"	59"

EMBOSSMENT PROFILES

FIBERGLASS DOORS AND SIDELIGHTS



EDGE (ESTATE PANEL DOORS)

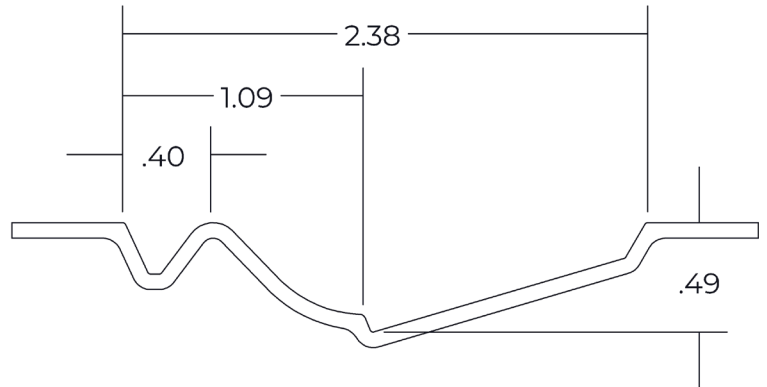

EDGE PLUS (ESTATE PLANK DOORS)

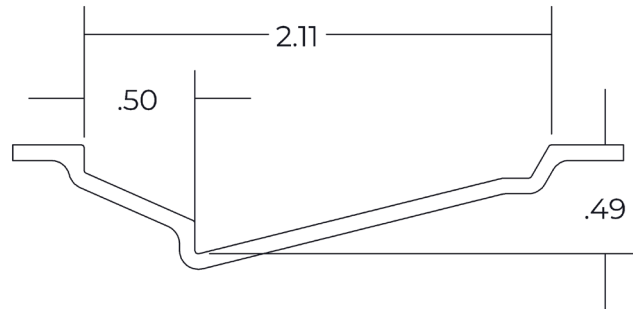

SHAKER (SHAKER PANEL DOORS)

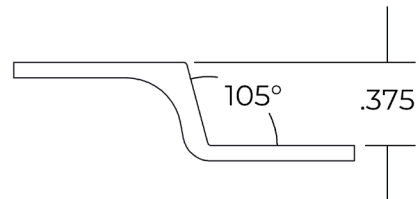

CLASSIC (PRO OAK DOORS)

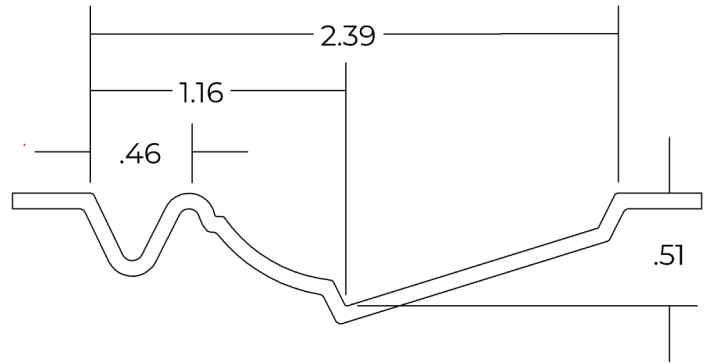

SOLID FLUSH

FIBERGLASS DOORS AND SIDELIGHTS



6'8" FLUSH

FIBERGLASS DOOR

FINE GRAIN | *TAN*

RIFT CUT | *TAN*

SATIN SMOOTH | *WHITE*

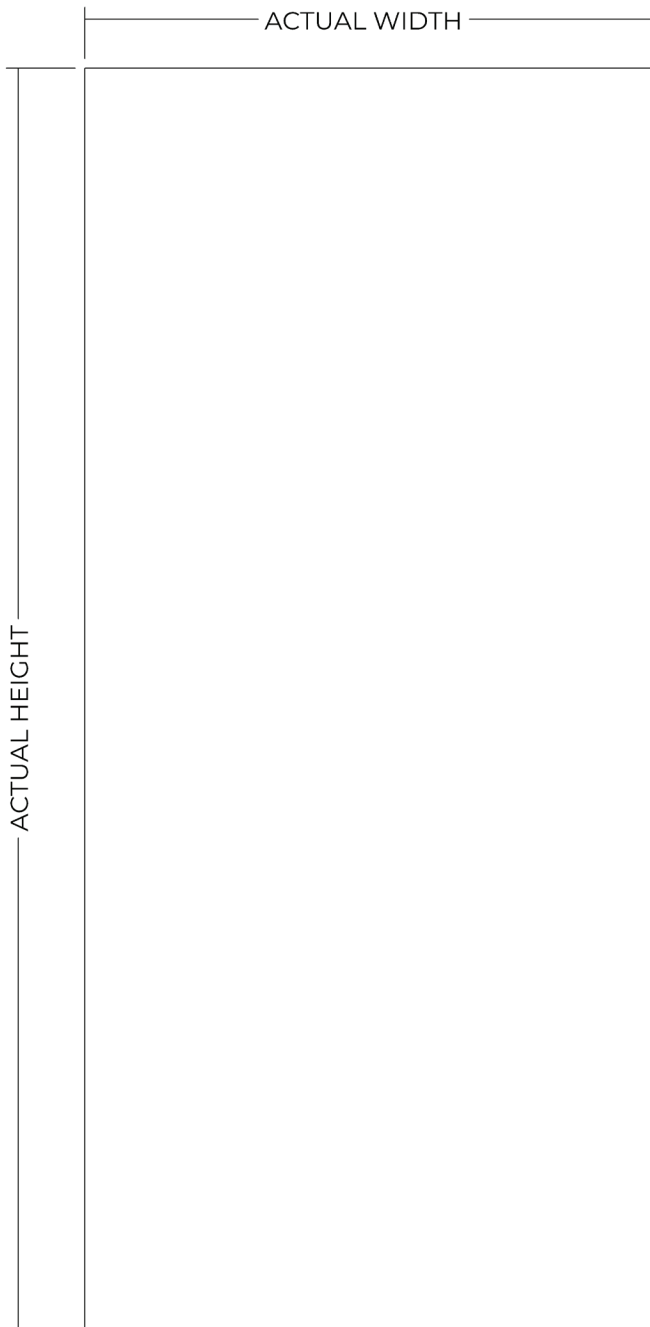

DOOR WIDTH	
NOMINAL	ACTUAL
2-6	29 3/4"
2-8	31 3/4"
2-10	33 3/4"
3-0	35 3/4"
3-6	41 3/4"

DOOR HEIGHT	
NOMINAL	ACTUAL
6-8	79"

GLASS OPTIONS	
SIZE	CUTOUT
8 x 6	9 x 7
8 x 36	9 x 37
7 x 64	8 x 65
8 x 64	9 x 65
22 x 10	23 x 11
22 x 15 1/4	23 x 16 1/4
22 x 36	23 x 37
22 x 48	23 x 49
22 x 60*	23 x 61
22 x 64	23 x 65
22 x 17	23 x 18

 ADA COMPLIANT*

6'8" FLUSH

FIBERGLASS SIDELIGHT

FINE GRAIN | *TAN*

RIFT CUT | *TAN*

SATIN SMOOTH | *WHITE*

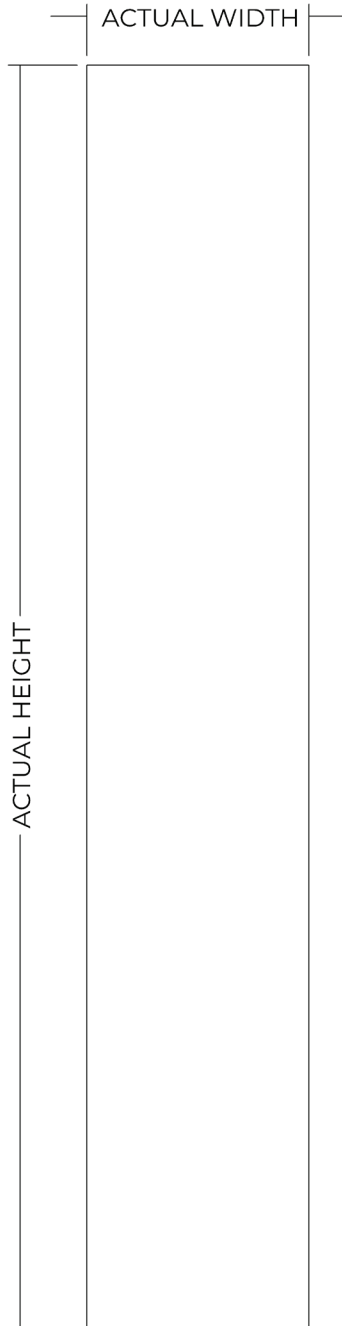

SIDELIGHT WIDTH	
NOMINAL	ACTUAL
1-0	11 7/8"
1-2	13 7/8"

SIDELIGHT HEIGHT	
NOMINAL	ACTUAL
6-8	79"

GLASS OPTIONS	
SIZE	CUTOUT
7 x 64	8 x 65
8 x 64	9 x 65

* Light frame required to verify cutout size

6'8" FLUSH w/1 LIGHT CUTOUT

FIBERGLASS SIDELIGHT

FINE GRAIN | TAN

RIFT CUT | TAN

SATIN SMOOTH | WHITE

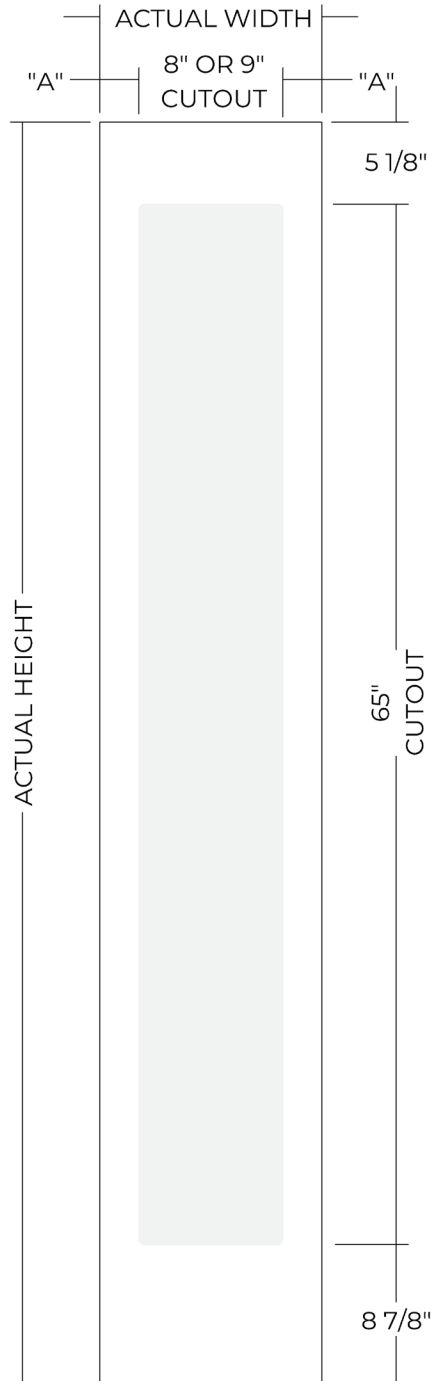

6'8" FLUSH W/ 8"X65" CUTOUT

SIDELIGHT WIDTH		
NOMINAL	ACTUAL	"A"
1-0	11 7/8"	1 15/16"
1-2	13 7/8"	2 15/16"

SIDELIGHT HEIGHT	
NOMINAL	ACTUAL
6-8	79"

6'8" FLUSH W/ 9"X65" CUTOUT

SIDELIGHT WIDTH		
NOMINAL	ACTUAL	"A"
1-0	11 7/8"	1 7/16"
1-2	13 7/8"	2 7/16"

SIDELIGHT HEIGHT	
NOMINAL	ACTUAL
6-8	79"

GLASS OPTIONS	
SIZE	CUTOUT
7 x 64	8 x 65
8 x 64	9 x 65

7'0" FLUSH FIBERGLASS DOOR

FINE GRAIN | *TAN*

RIFT CUT | *TAN*

SATIN SMOOTH | *WHITE*

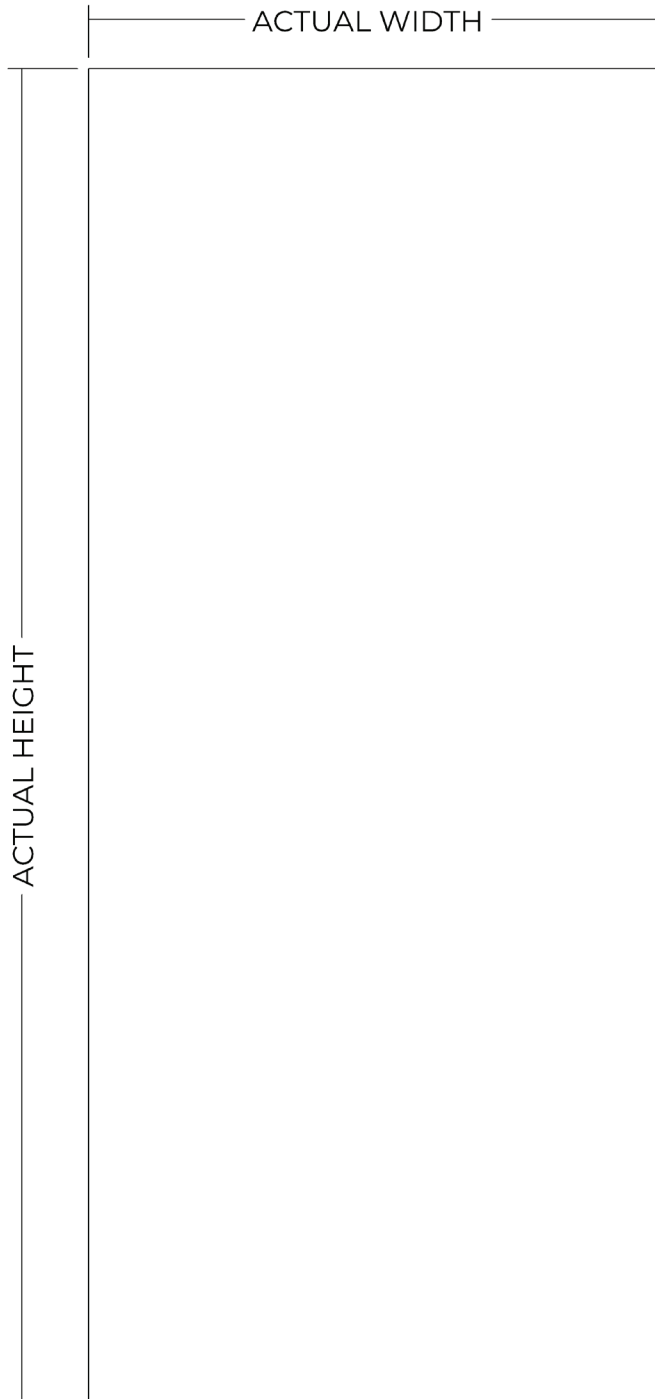

DOOR WIDTH

NOMINAL	ACTUAL
2-6	29 3/4"
2-8	31 3/4"
2-10	33 3/4"
3-0	35 3/4"
3-6	41 3/4"

DOOR HEIGHT

NOMINAL	ACTUAL
7-0	83"

GLASS OPTIONS

SIZE	CUTOUT
8 x 6	9 x 7
8 x 36	9 x 37
7 x 64	8 x 65
8 x 64	9 x 65
22 x 10	23 x 11
22 x 36	23 x 37
22 x 48	23 x 49
22 x 60*	23 x 65
22 x 64	23 x 61
22 x 17	23 x 18



8'0" FLUSH

FIBERGLASS DOOR

FINE GRAIN | *TAN*

RIFT CUT | *TAN*

SATIN SMOOTH | *WHITE*

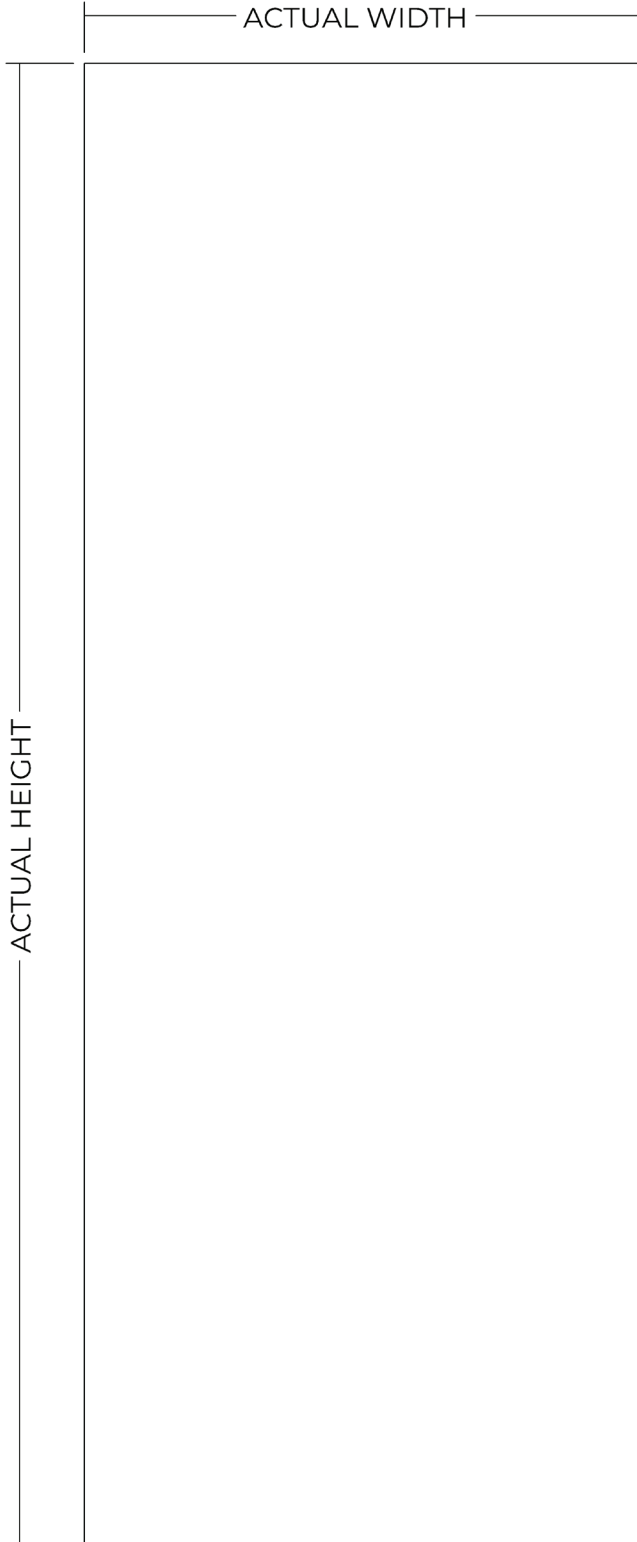

DOOR WIDTH

NOMINAL	ACTUAL
2-6	29 3/4"
2-8	31 3/4"
2-10	33 3/4"
3-0	35 3/4"
3-6	41 3/4"

DOOR HEIGHT

NOMINAL	ACTUAL
8-0	95"

GLASS OPTIONS

SIZE	CUTOUT
8 x 80	9 x 81
22 x 76*	23 x 77
22 x 80	23 x 81
22 x 12	23 x 13
22 x 17	23 x 18



ADA COMPLIANT*

8'0" FLUSH

FIBERGLASS SIDELIGHT

FINE GRAIN | *TAN*

RIFT CUT | *TAN*

SATIN SMOOTH | *WHITE*

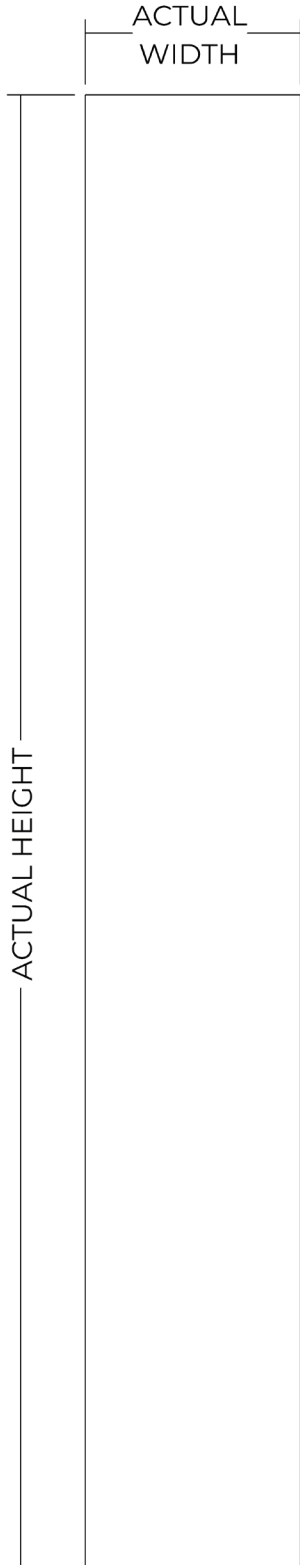

SIDELIGHT WIDTH	
NOMINAL	ACTUAL
1-0	11 7/8"
1-2	13 7/8"

SIDELIGHT HEIGHT	
NOMINAL	ACTUAL
8-0	95"

GLASS OPTIONS	
SIZE	CUTOUT
8 x 80	9 x 81

8'0" FLUSH w/1 LIGHT CUTOUT

FIBERGLASS SIDELIGHT

FINE GRAIN | TAN

RIFT CUT | TAN

SATIN SMOOTH | WHITE

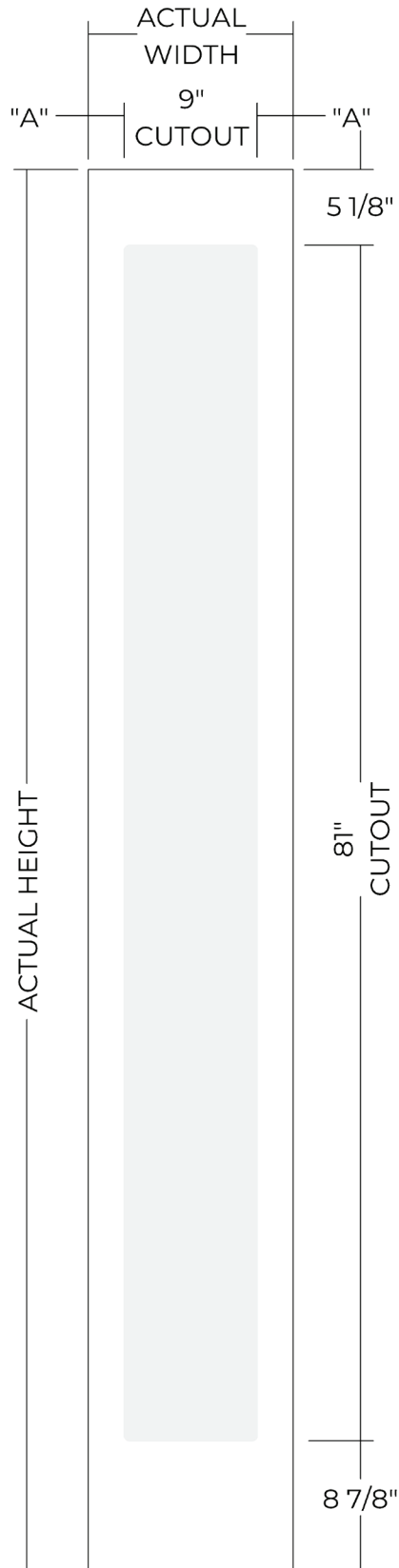

8'0" FLUSH W/9"x81" CUTOUT

SIDELIGHT WIDTH		
NOMINAL	ACTUAL	"A"
1-0	11 7/8"	1 7/16"
1-2	13 7/8"	2 7/16"

SIDELIGHT HEIGHT	
NOMINAL	ACTUAL
8-0	95"

GLASS OPTIONS	
SIZE	CUTOUT
8 x 80	9 x 81

ESTATE

FIBERGLASS DOORS AND SIDELIGHTS



6'8" 6 PANEL

FIBERGLASS DOOR

RIFT CUT | TAN

SATIN SMOOTH | WHITE

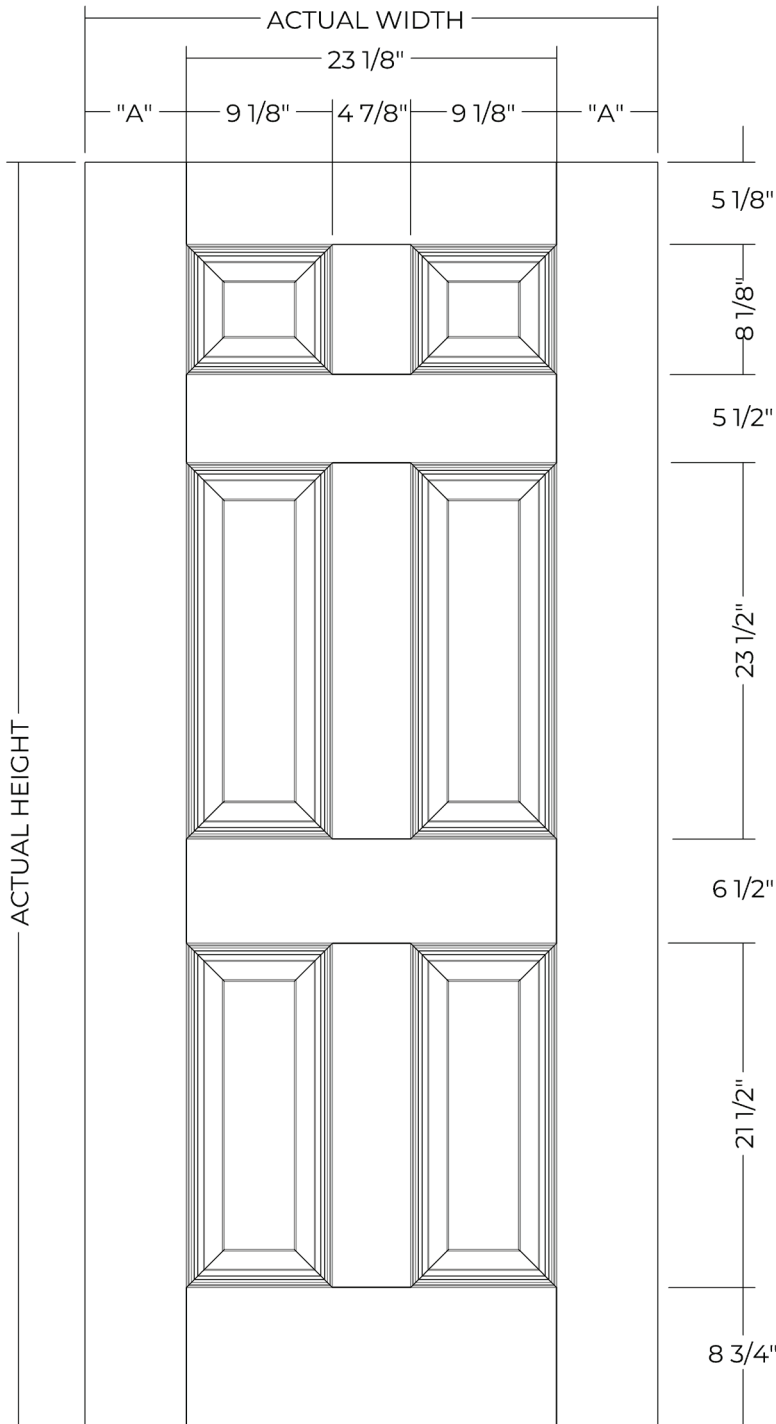

DOOR WIDTH		
NOMINAL	ACTUAL	"A"
2-8	31 3/4"	4 5/16"
2-10	33 3/4"	5 5/16"
3-0	35 3/4"	6 5/16"

DOOR HEIGHT	
NOMINAL	ACTUAL
6-8	79"

GLASS OPTIONS	
SIZE	CUTOUT
22 x 10	23 x 11
22 x 36	23 x 37
22 x 64	23 x 65



ESTATE

6'8" 6 PANEL NARROW

FIBERGLASS DOOR

SATIN SMOOTH | WHITE

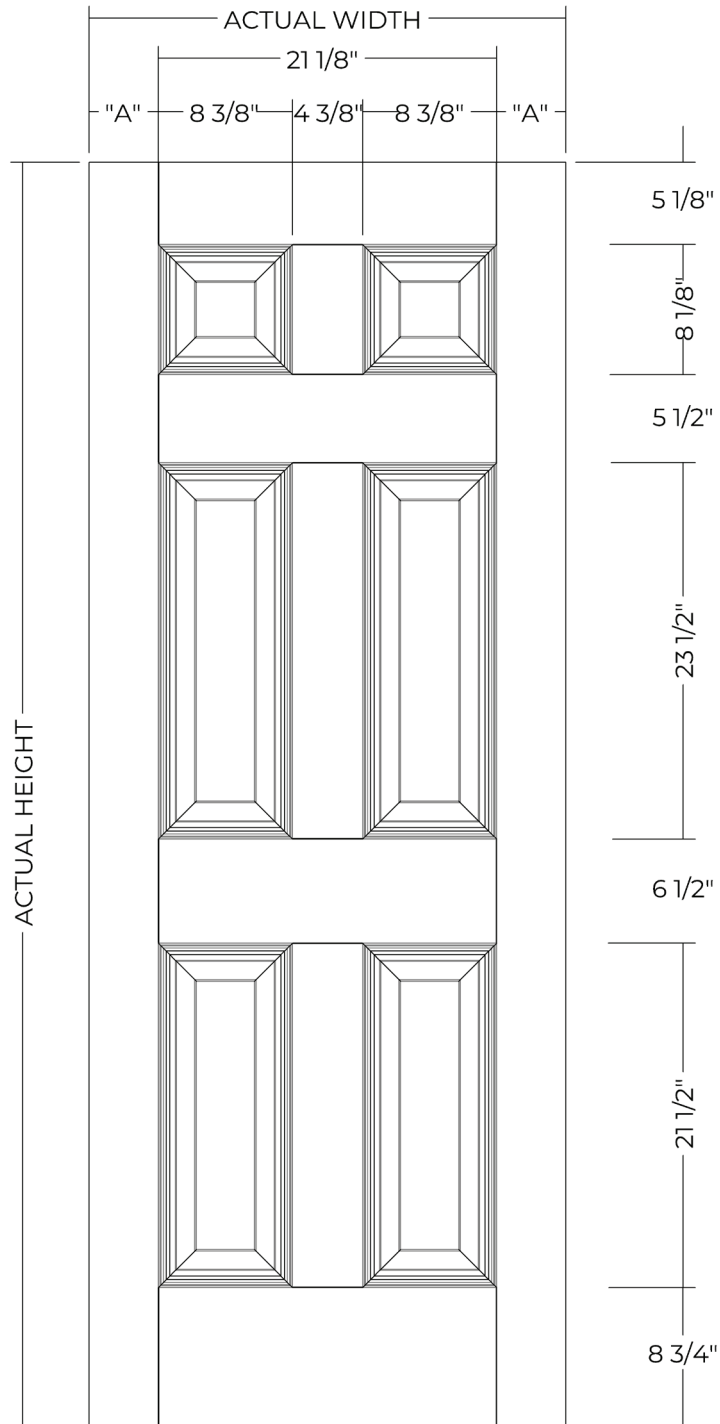

DOOR WIDTH

NOMINAL	ACTUAL	"A"
2-6*	29 3/4"	4 5/16"

DOOR HEIGHT

NOMINAL	ACTUAL
6-8	79"

GLASS OPTIONS

SIZE	CUTOUT
20 x 36	21 x 37
20 x 64	21 x 65

* 2 3/8" Backset Only

ESTATE

6'8" ADA 6 PANEL

FIBERGLASS DOOR

SATIN SMOOTH | WHITE

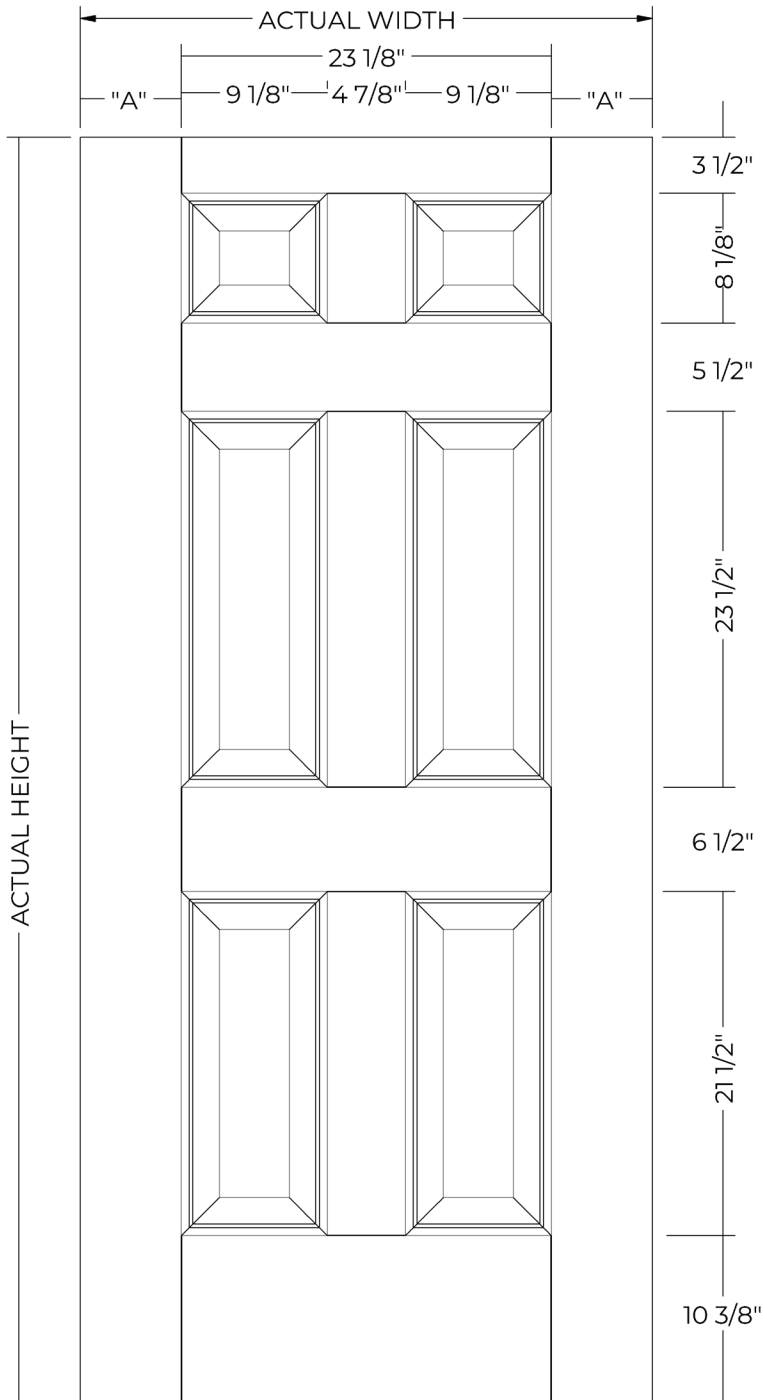

DOOR WIDTH		
NOMINAL	ACTUAL	"A"
2-8	31 3/4"	4 5/16"
2-10	33 3/4"	5 5/16"
3-0	35 3/4"	6 5/16"

DOOR HEIGHT	
NOMINAL	ACTUAL
6-8	79"

GLASS OPTIONS	
SIZE	CUTOUT
22 x 36	23 x 37
22 x 64	23 x 65



ESTATE

6'8" 4 PANEL BLANK TOP

FIBERGLASS DOOR

SATIN SMOOTH | WHITE

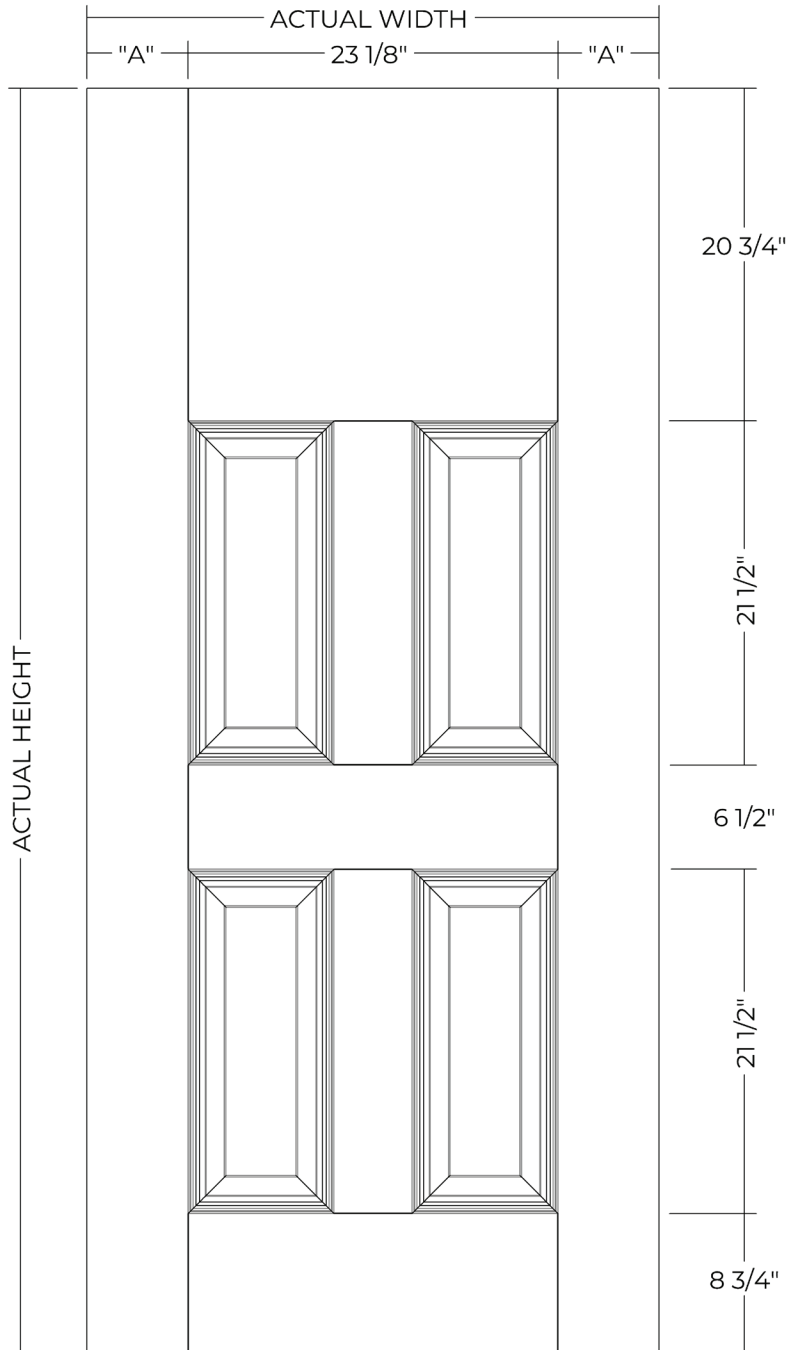

DOOR WIDTH		
NOMINAL	ACTUAL	"A"
2-8	31 3/4"	4 5/16"
2-10	33 3/4"	5 5/16"
3-0	35 3/4"	6 5/16"

DOOR HEIGHT	
NOMINAL	ACTUAL
6-8	79"

GLASS OPTIONS	
SIZE	CUTOUT
8 x 6	9 x 7
22 x 10	23 x 11
22 x 36	23 x 37
22 x 64	23 x 65



ESTATE

6'8" 2 PANEL 3/4 TOP

FIBERGLASS DOOR

RIFT CUT | TAN

SATIN SMOOTH | WHITE

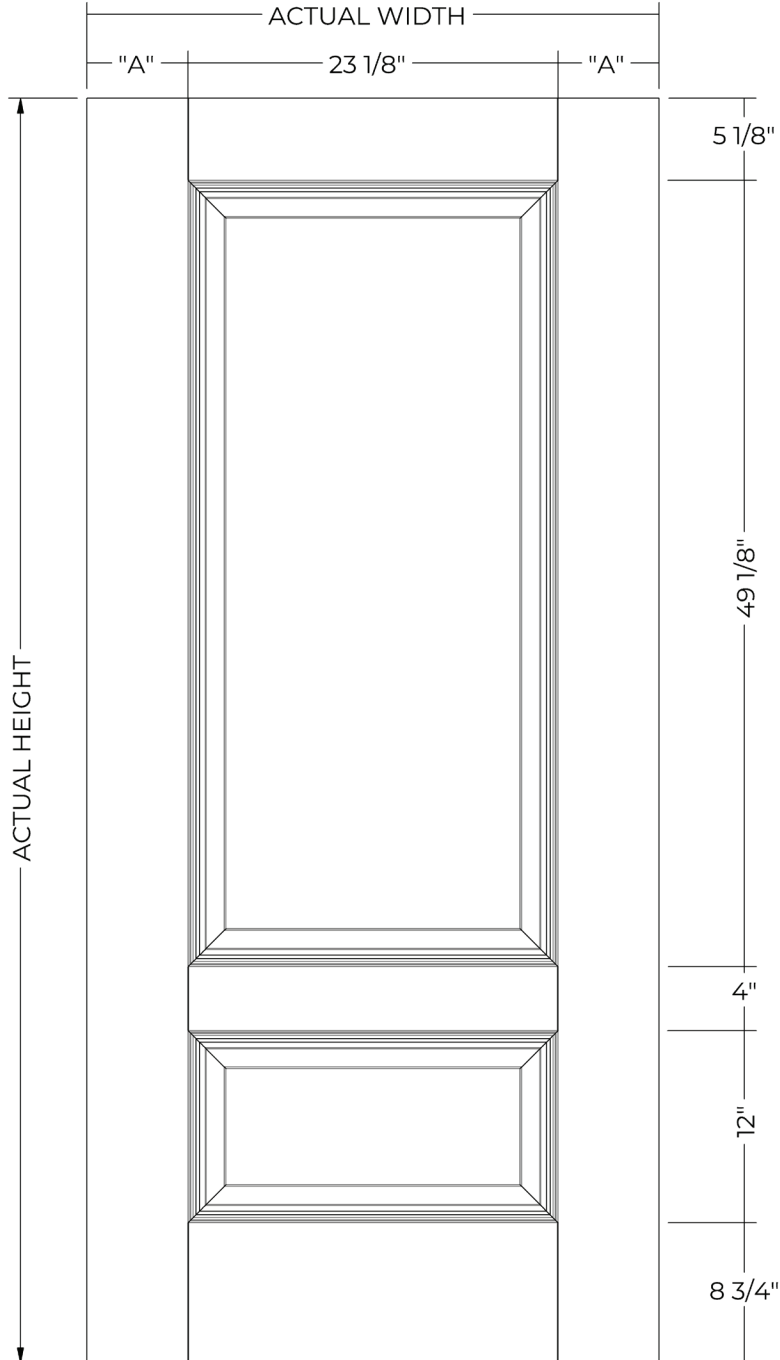

DOOR WIDTH		
NOMINAL	ACTUAL	"A"
2-8	31 3/4"	4 5/16"
2-10	33 3/4"	5 5/16"
3-0	35 3/4"	6 5/16"

DOOR HEIGHT	
NOMINAL	ACTUAL
6-8	79"

GLASS OPTIONS	
SIZE	CUTOUT
22 x 48	23 x 49
22 x 64	23 x 65

ESTATE

6'8" 3 PANEL 3/4 TOP

FIBERGLASS DOOR

SATIN SMOOTH | WHITE

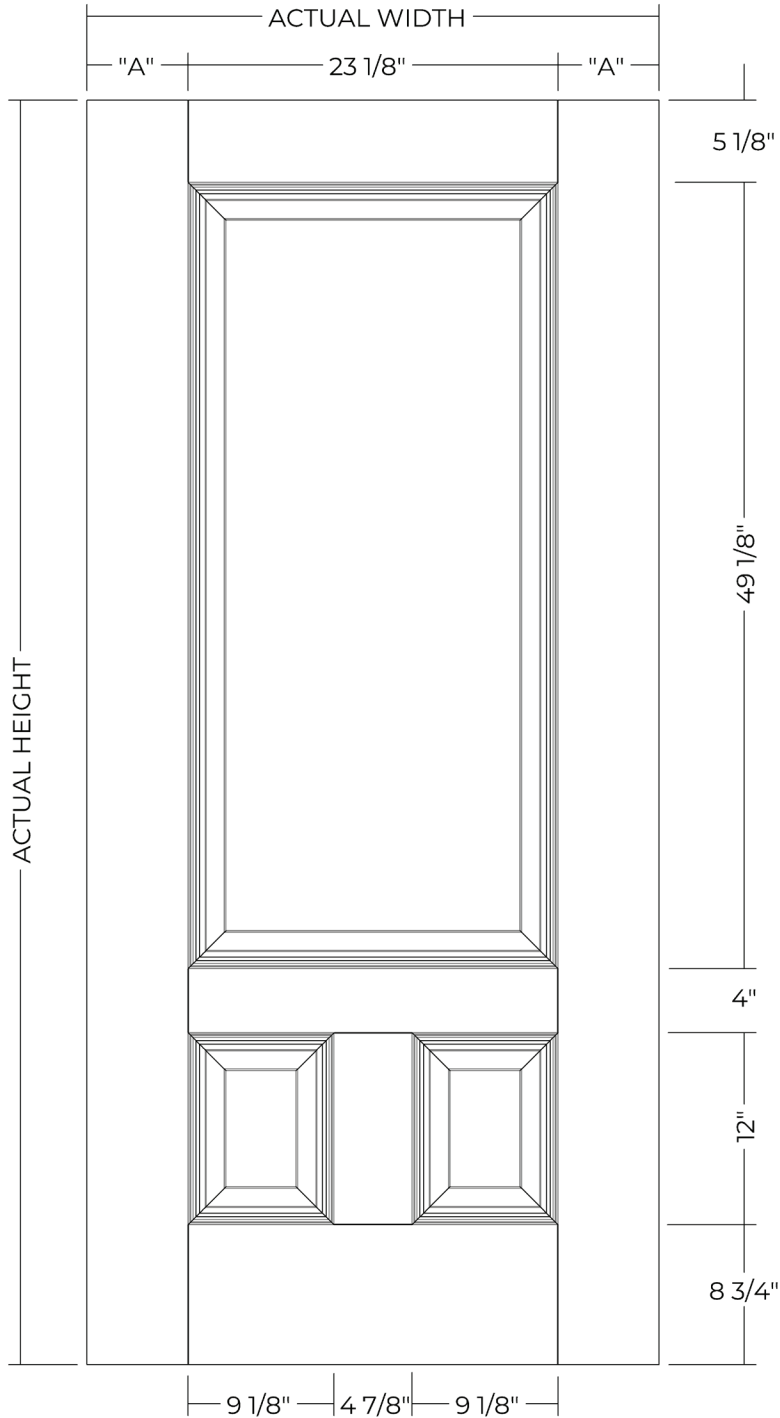

DOOR WIDTH		
NOMINAL	ACTUAL	"A"
2-8	31 3/4"	4 5/16"
2-10	33 3/4"	5 5/16"
3-0	35 3/4"	6 5/16"

DOOR HEIGHT	
NOMINAL	ACTUAL
6-8	79"

GLASS OPTIONS	
SIZE	CUTOUT
22 x 48	23 x 49
22 x 64	23 x 65



ESTATE

6'8" 2 PANEL SQUARE

FIBERGLASS DOOR

RIFT CUT | *TAN*

| SATIN SMOOTH | *WHITE*

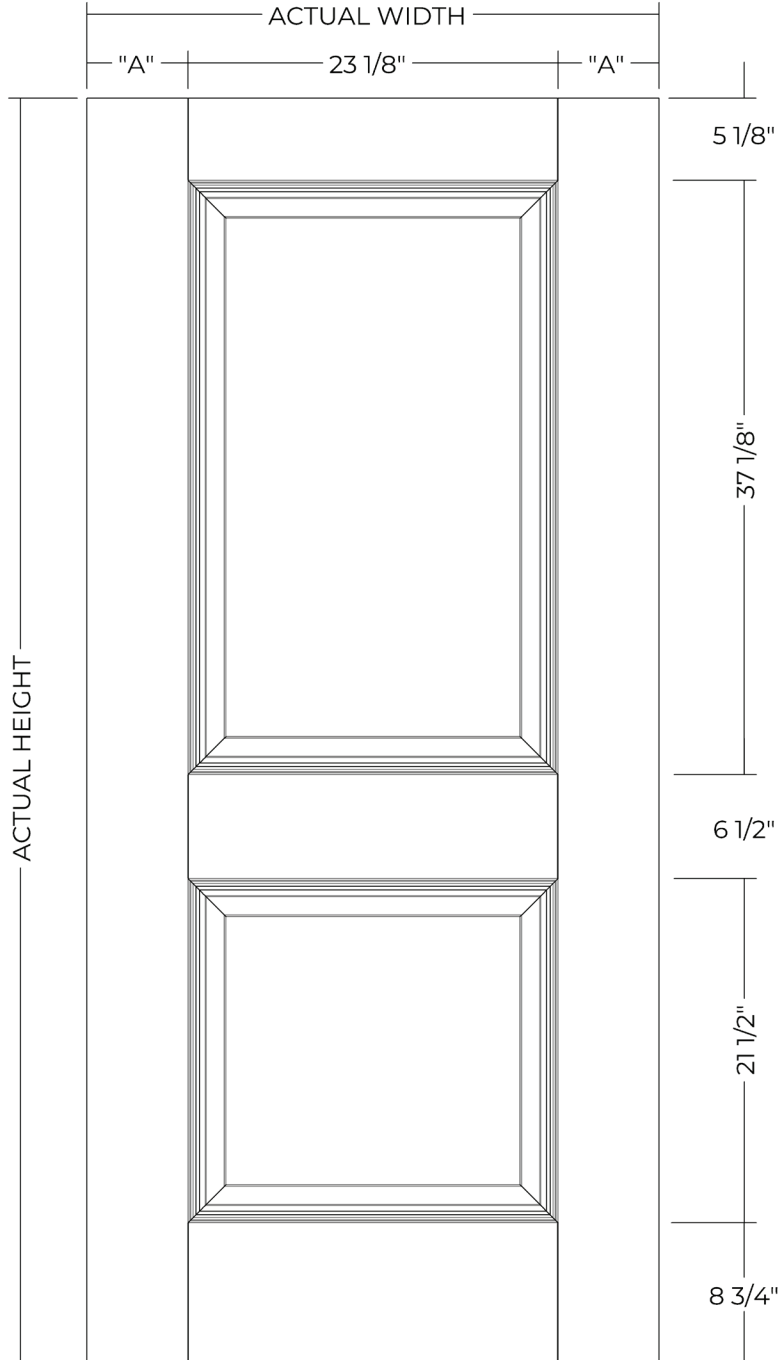

DOOR WIDTH		
NOMINAL	ACTUAL	"A"
2-8	31 3/4"	4 5/16"
2-10	33 3/4"	5 5/16"
3-0	35 3/4"	6 5/16"

DOOR HEIGHT	
NOMINAL	ACTUAL
6-8	79"

GLASS OPTIONS	
SIZE	CUTOUT
22 x 36	23 x 37
22 x 64	23 x 65



ESTATE

6'8" ADA 2 PANEL SQUARE

FIBERGLASS DOOR

SATIN SMOOTH | WHITE

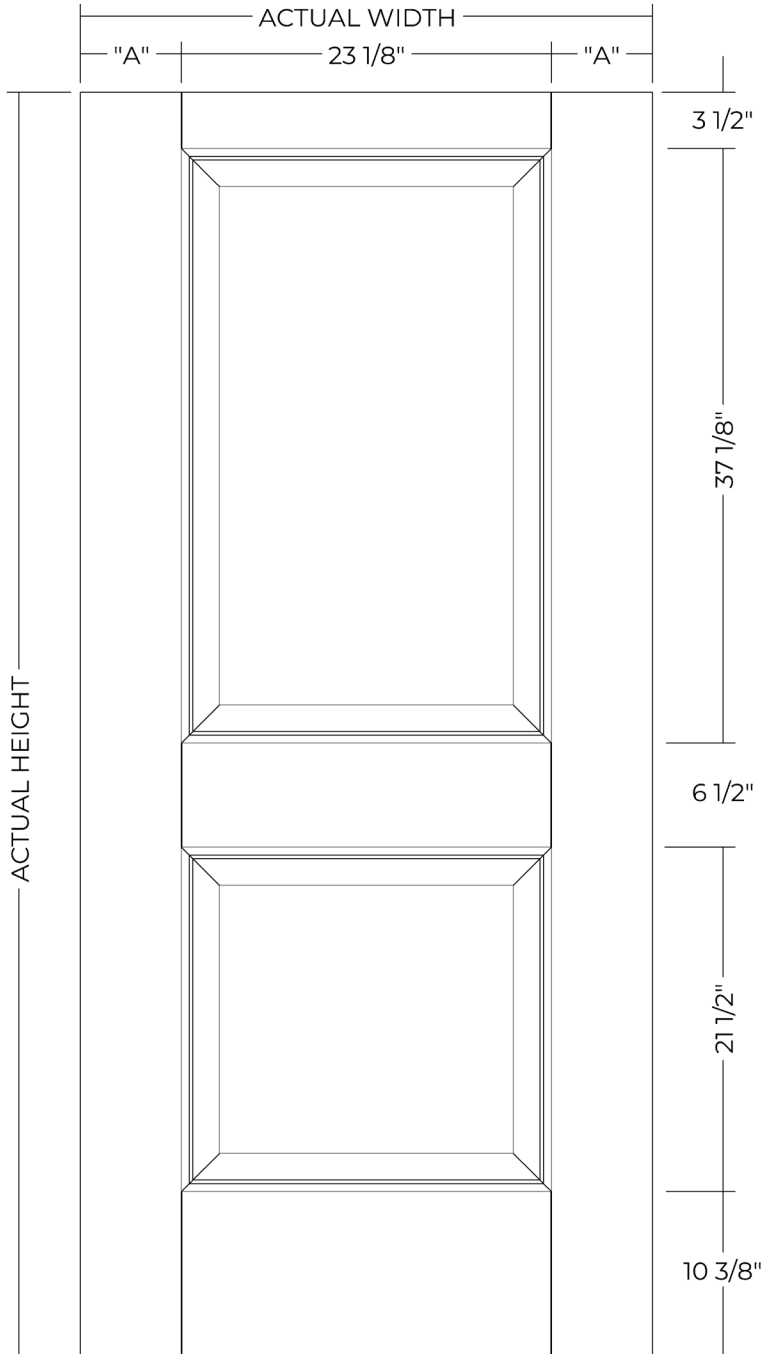

DOOR WIDTH		
NOMINAL	ACTUAL	"A"
2-8	31 3/4"	4 5/16"
2-10	33 3/4"	5 5/16"
3-0	35 3/4"	6 5/16"

DOOR HEIGHT	
NOMINAL	ACTUAL
6-8	79"

GLASS OPTIONS	
SIZE	CUTOUT
22 x 36*	23 x 37
22 x 64*	23 x 65



ESTATE

6'8" 2 PANEL CAMBER

FIBERGLASS DOOR

SATIN SMOOTH | WHITE

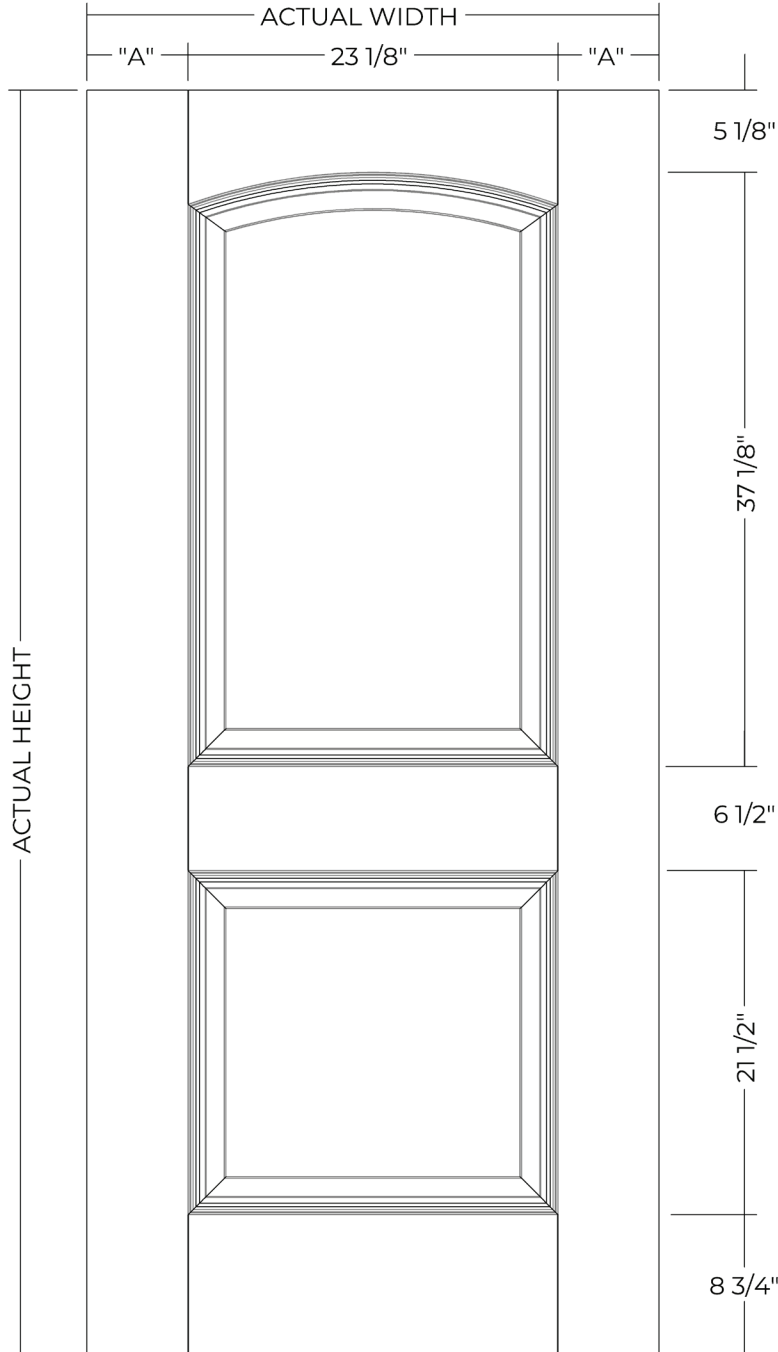

DOOR WIDTH		
NOMINAL	ACTUAL	"A"
2-8	31 3/4"	4 5/16"
2-10	33 3/4"	5 5/16"
3-0	35 3/4"	6 5/16"

DOOR HEIGHT	
NOMINAL	ACTUAL
6-8	79"

GLASS OPTIONS	
SIZE	CUTOUT
22 x 36	23 x 37
22 x 64	23 x 65



ESTATE

6'8" 2 PANEL CAMBER PLANK

FIBERGLASS DOOR

SATIN SMOOTH | WHITE

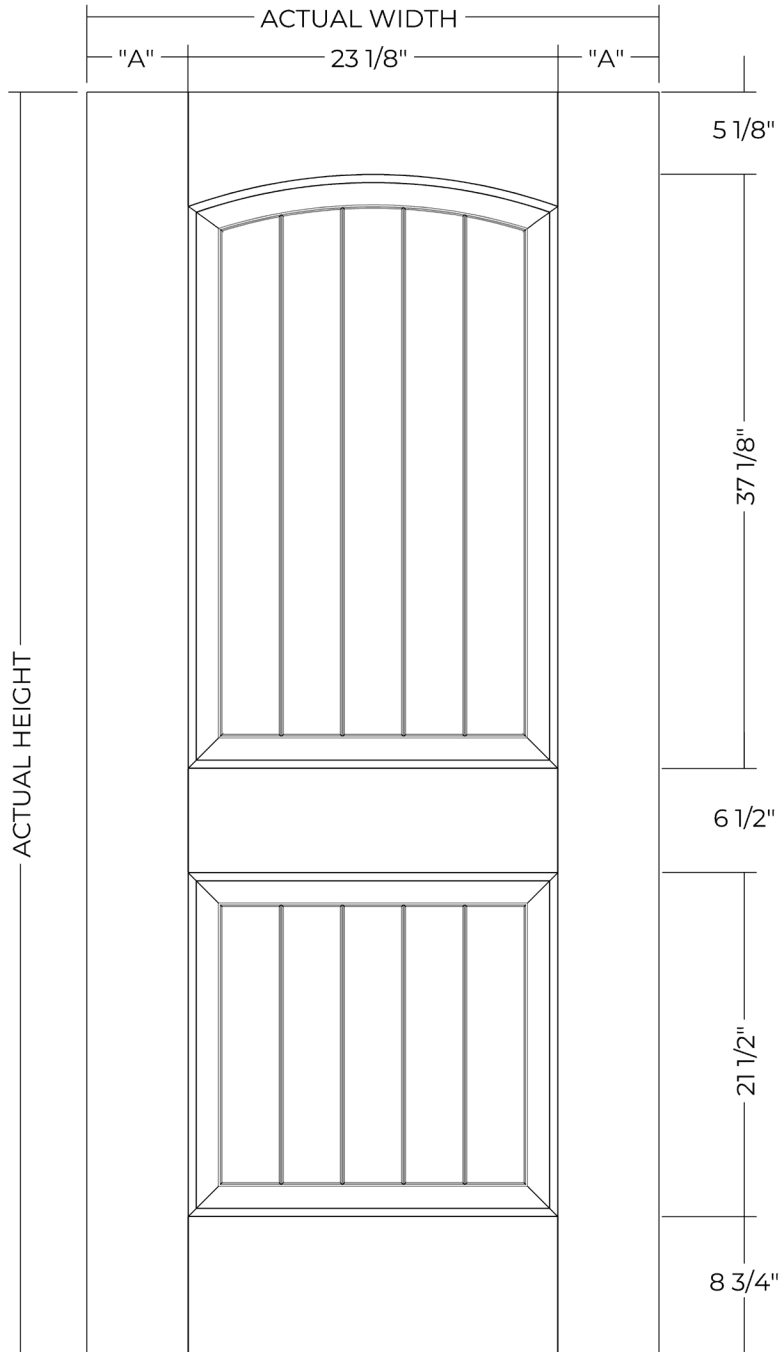

DOOR WIDTH		
NOMINAL	ACTUAL	"A"
2-8	31 3/4"	4 5/16"
2-10	33 3/4"	5 5/16"
3-0	35 3/4"	6 5/16"

DOOR HEIGHT	
NOMINAL	ACTUAL
6-8	79"

GLASS OPTIONS	
SIZE	CUTOUT
22 x 36	23 x 37
22 x 64	23 x 65

ESTATE

6'8" 3/4 LIGHT w/9x49 CUTOUT

FIBERGLASS SIDELIGHT

RIFT CUT | TAN | SATIN SMOOTH | WHITE

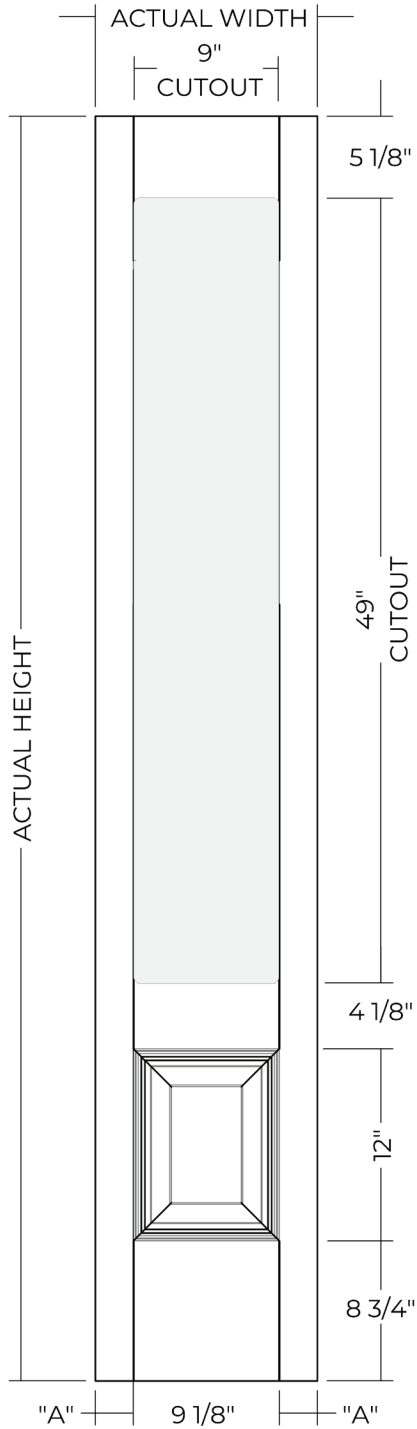

SIDELIGHT WIDTH		
NOMINAL	ACTUAL	"A"
1-0	11 7/8"	1 7/16"
1-2	13 7/8"	2 7/16"

SIDELIGHT HEIGHT	
NOMINAL	ACTUAL
6-8	79"

GLASS OPTIONS	
SIZE	CUTOUT
8 x 48	9 x 49

ESTATE

6'8" 1/2 LIGHT w/9x37 CUTOUT

FIBERGLASS SIDELIGHT

RIFT CUT | TAN | SATIN SMOOTH | WHITE

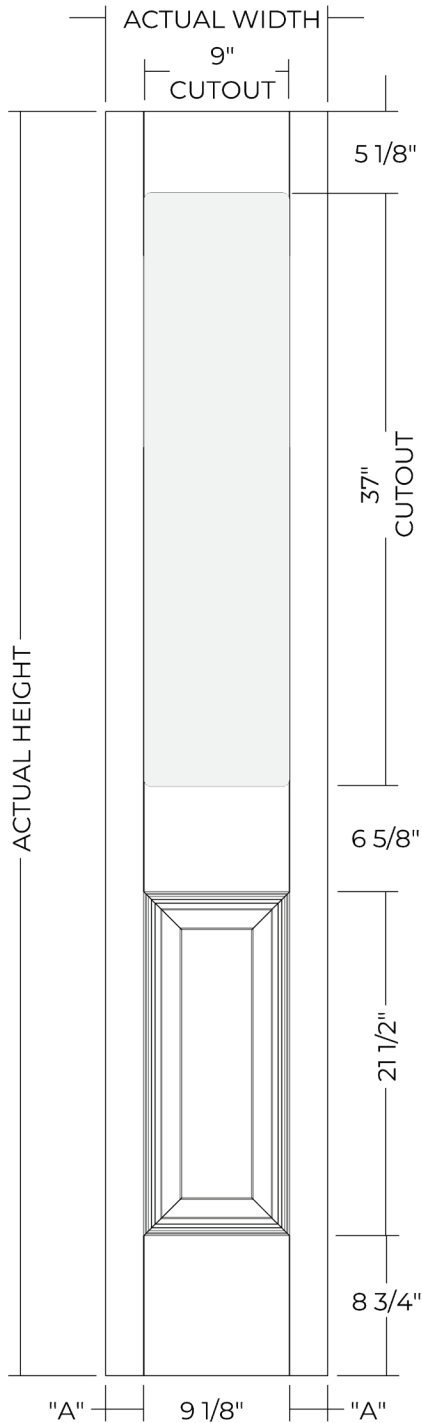

SIDELIGHT WIDTH		
NOMINAL	ACTUAL	"A"
1-0	11 7/8"	1 7/16"
1-2	13 7/8"	2 7/16"

SIDELIGHT HEIGHT	
NOMINAL	ACTUAL
6-8	79"

GLASS OPTIONS	
SIZE	CUTOUT
8 x 36	9 x 37

ESTATE

7'0" 6 PANEL

FIBERGLASS DOOR

SATIN SMOOTH | WHITE

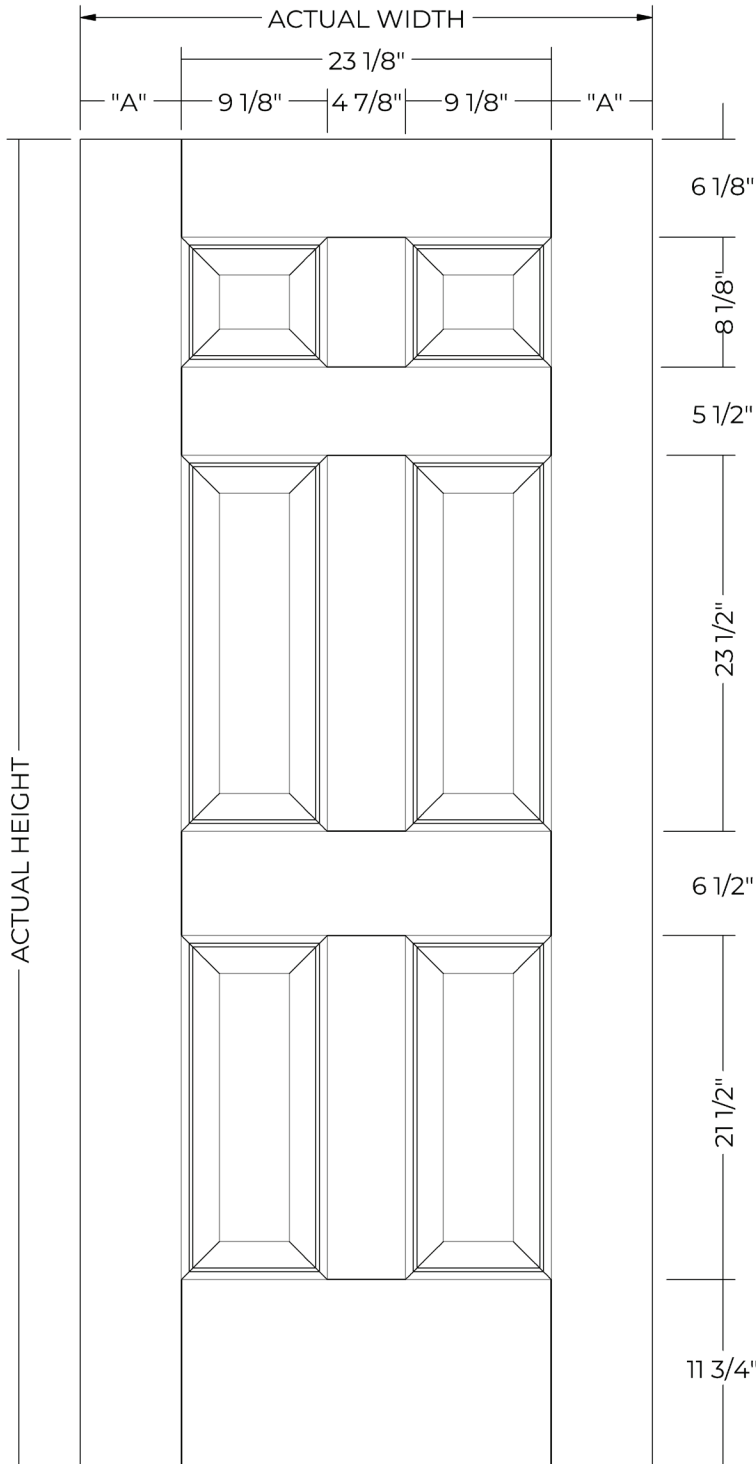

DOOR WIDTH		
NOMINAL	ACTUAL	"A"
2-8	31 3/4"	4 5/16"
2-10	33 3/4"	5 5/16"
3-0	35 3/4"	6 5/16"

DOOR HEIGHT	
NOMINAL	ACTUAL
7-0	83"

GLASS OPTIONS	
SIZE	CUTOUT
22 x 36*	23 x 37
22 x 64*	23 x 65



ADA COMPLIANT*

ESTATE

7'0" 2 PANEL SQUARE

FIBERGLASS DOOR

SATIN SMOOTH | WHITE

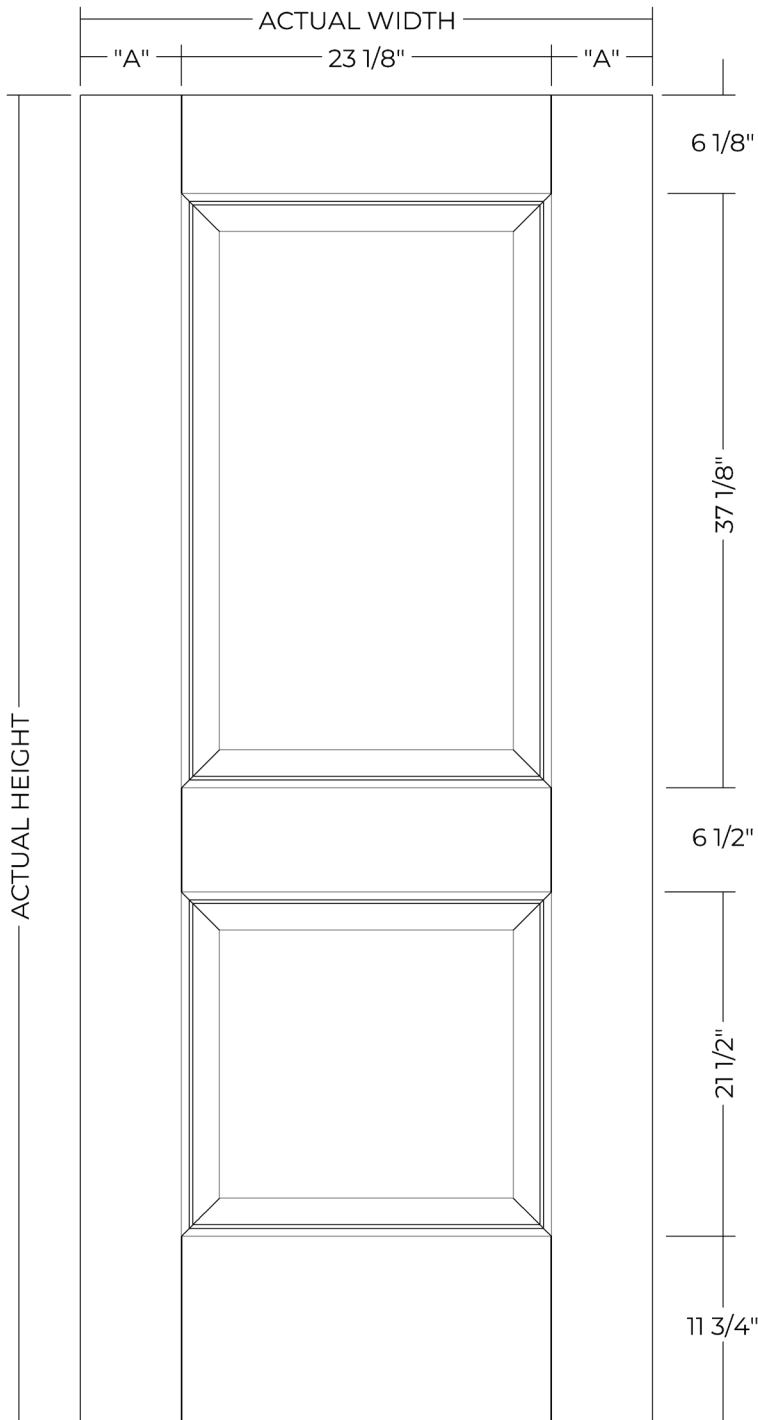

DOOR WIDTH		
NOMINAL	ACTUAL	"A"
2-8	31 3/4"	4 5/16"
2-10	33 3/4"	5 5/16"
3-0	35 3/4"	6 5/16"

DOOR HEIGHT	
NOMINAL	ACTUAL
7-0	83"

GLASS OPTIONS	
SIZE	CUTOUT
22 x 36*	23 x 37
22 x 64*	23 x 65



ADA COMPLIANT*

ESTATE

8'0" 6 PANEL

FIBERGLASS DOOR

RIFT CUT | TAN | SATIN SMOOTH | WHITE

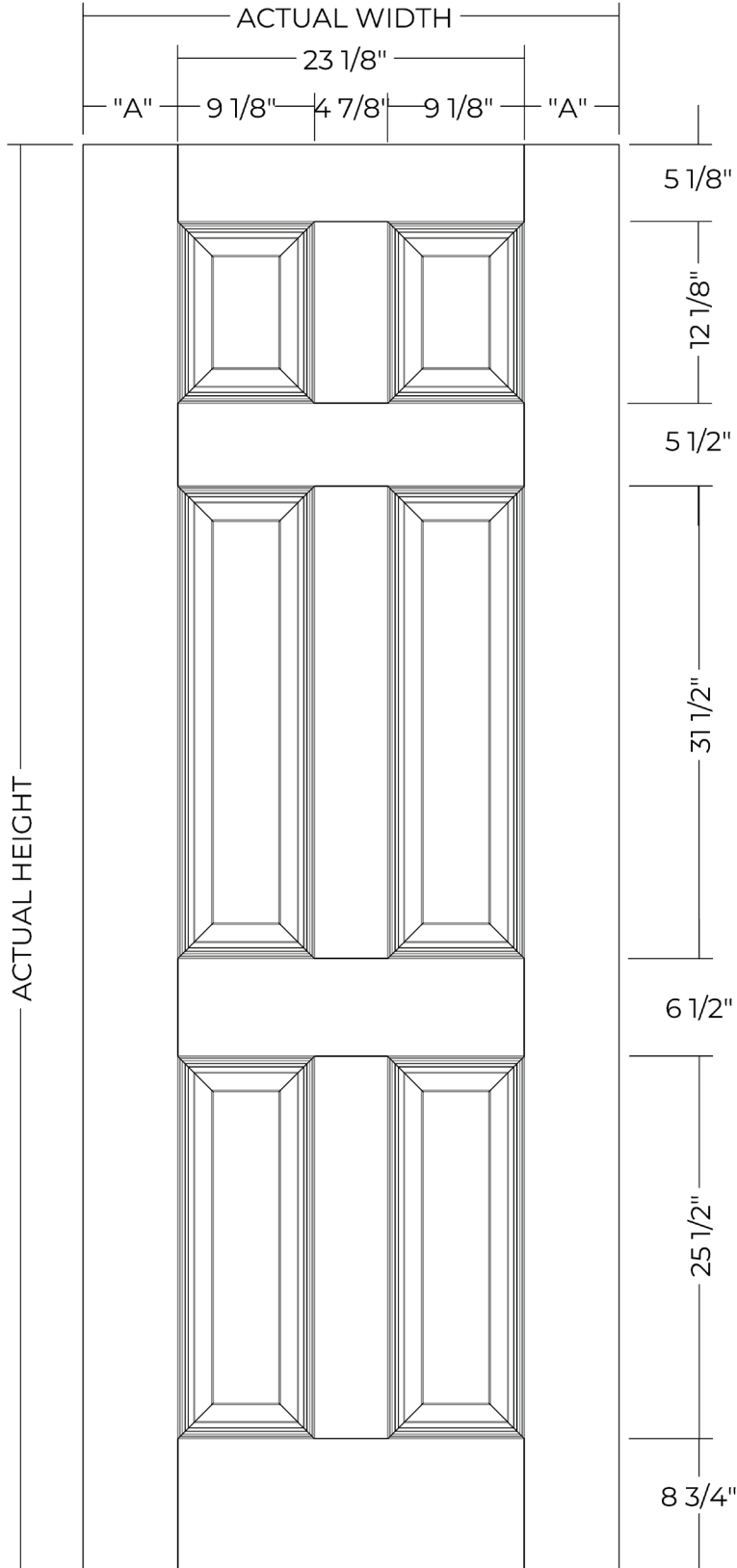

DOOR WIDTH		
NOMINAL	ACTUAL	"A"
2-8	31 3/4"	4 5/16"
2-10	33 3/4"	5 5/16"
3-0	35 3/4"	6 5/16"

DOOR HEIGHT	
NOMINAL	ACTUAL
8-0	95"

GLASS OPTIONS	
SIZE	CUTOUT
22 x 48	23 x 49
22 x 80	23 x 81



ESTATE

8'0" 2 PANEL 3/4 TOP

FIBERGLASS DOOR

RIFT CUT | TAN | SATIN SMOOTH | WHITE

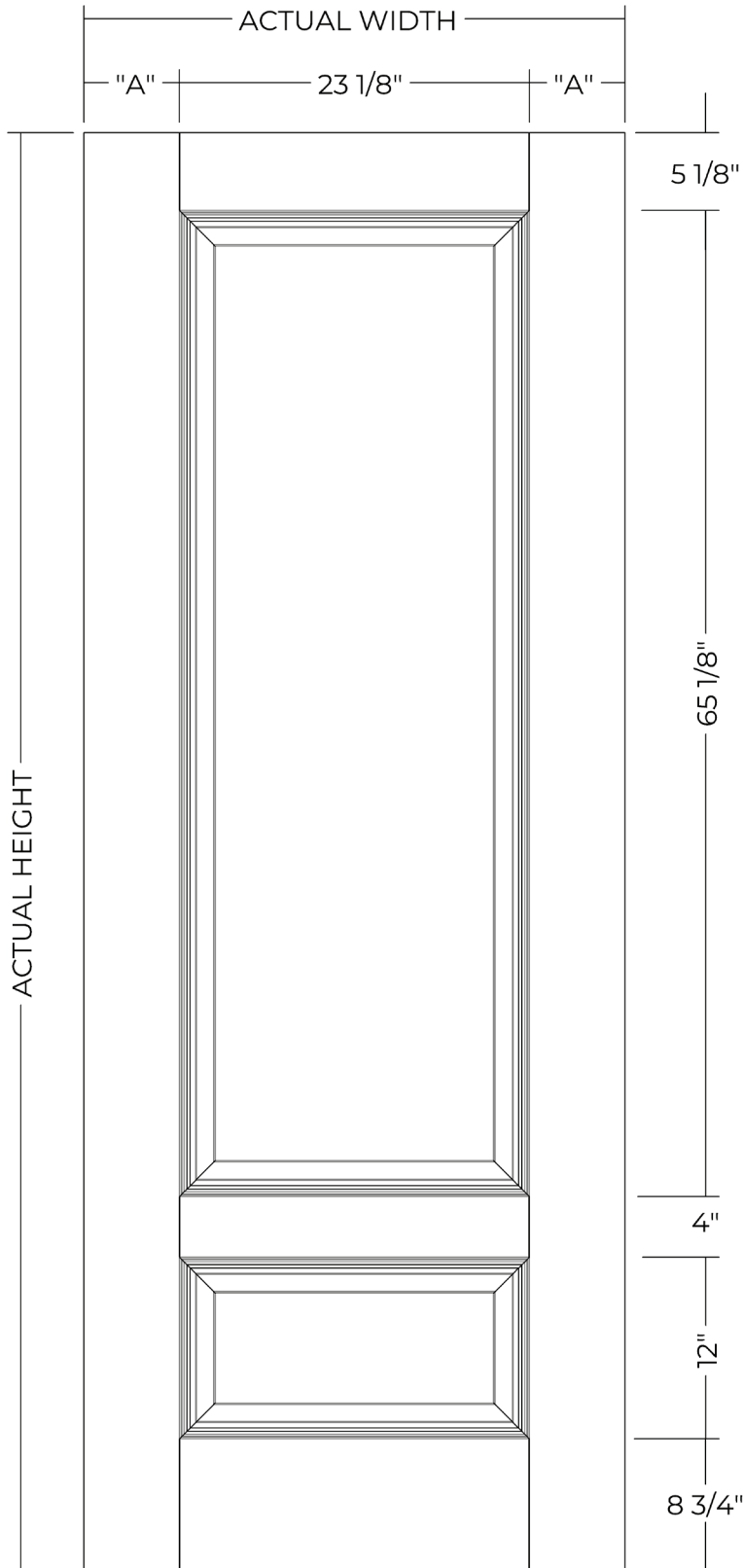

DOOR WIDTH		
NOMINAL	ACTUAL	"A"
2-8	31 3/4"	4 5/16"
2-10	33 3/4"	5 5/16"
3-0	35 3/4"	6 5/16"

DOOR HEIGHT	
NOMINAL	ACTUAL
8-0	95"

GLASS OPTIONS	
SIZE	CUTOUT
22 x 64	23 x 65
22 x 80	23 x 81

ESTATE

8'0" 2 PANEL SQUARE

FIBERGLASS DOOR

RIFT CUT | TAN | SATIN SMOOTH | WHITE

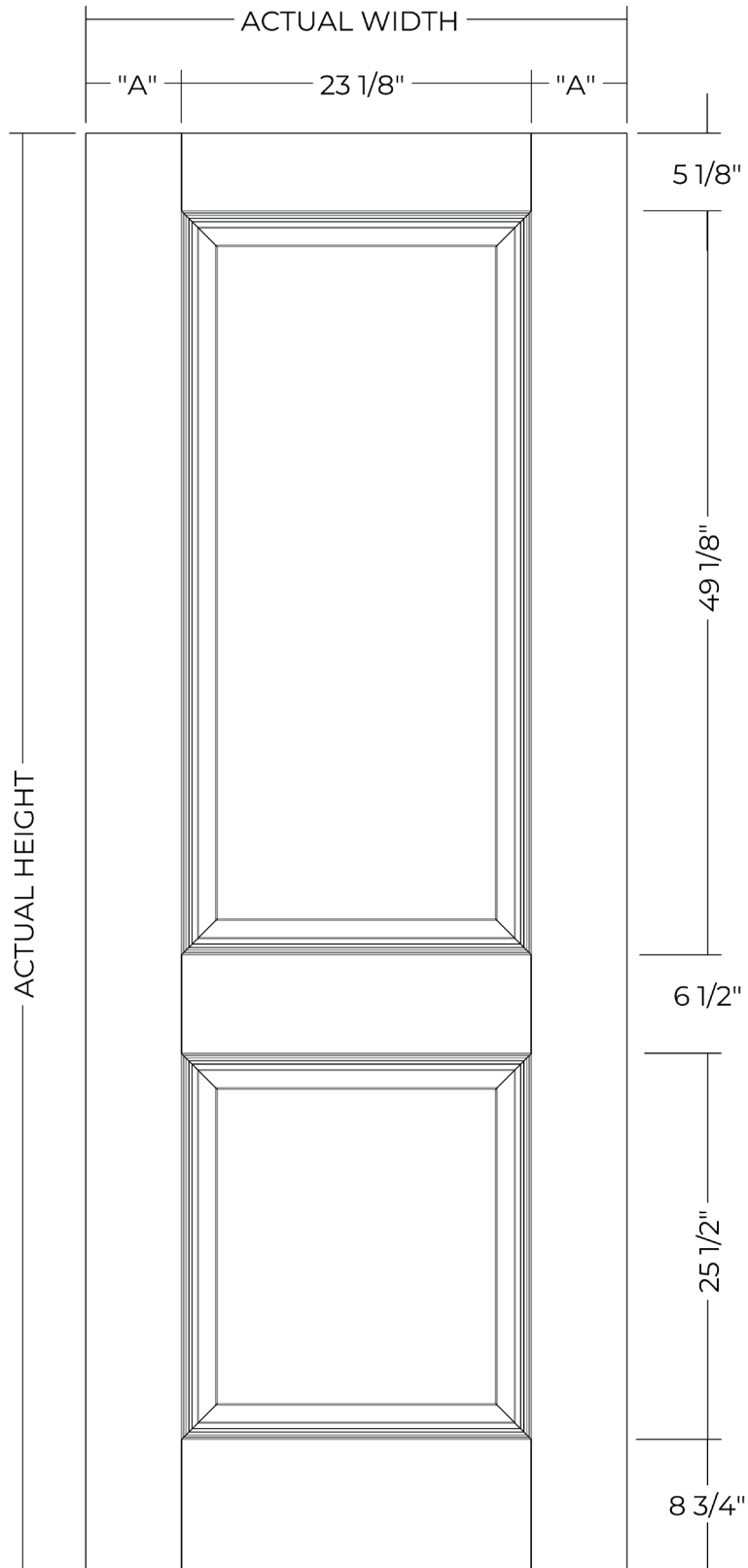

DOOR WIDTH		
NOMINAL	ACTUAL	"A"
2-8	31 3/4"	4 5/16"
2-10	33 3/4"	5 5/16"
3-0	35 3/4"	6 5/16"

DOOR HEIGHT	
NOMINAL	ACTUAL
8-0	95"

GLASS OPTIONS	
SIZE	CUTOUT
22 x 48	23 x 49
22 x 80	23 x 81



ESTATE

8'0" 3/4 LIGHT w/9x65 CUTOUT

FIBERGLASS SIDELIGHT

RIFT CUT | TAN

SATIN SMOOTH | WHITE

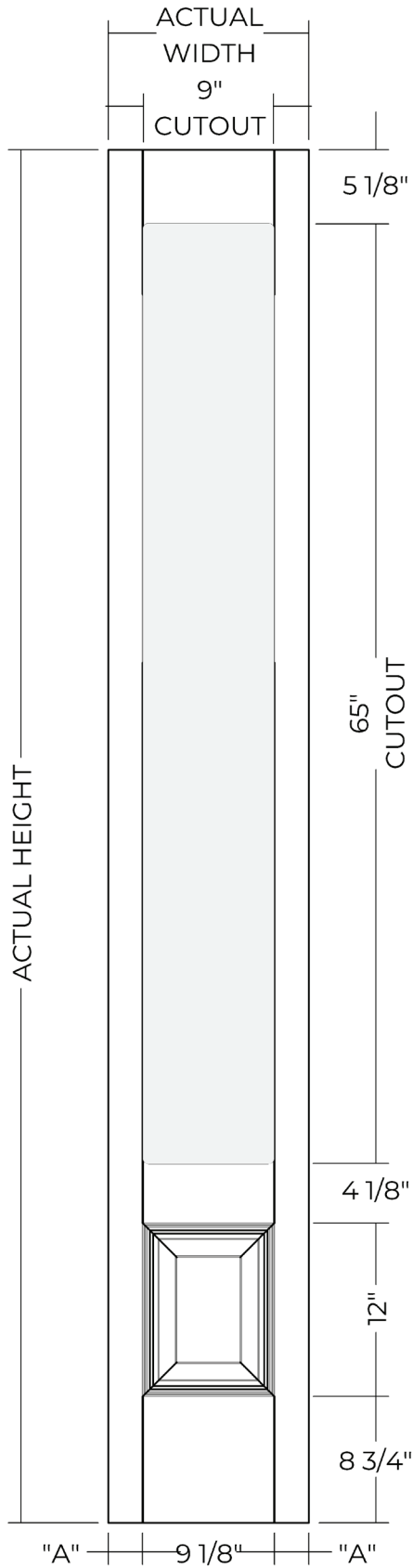

SIDELIGHT WIDTH		
NOMINAL	ACTUAL	"A"
1-0	11 7/8"	1 7/16"
1-2	13 7/8"	2 7/16"

SIDELIGHT HEIGHT	
NOMINAL	ACTUAL
8-0	95"

GLASS OPTIONS	
SIZE	CUTOUT
8 x 64	9 x 65

ESTATE

8'0" 1/2 LIGHT w/CUTOUT

FIBERGLASS SIDELIGHT

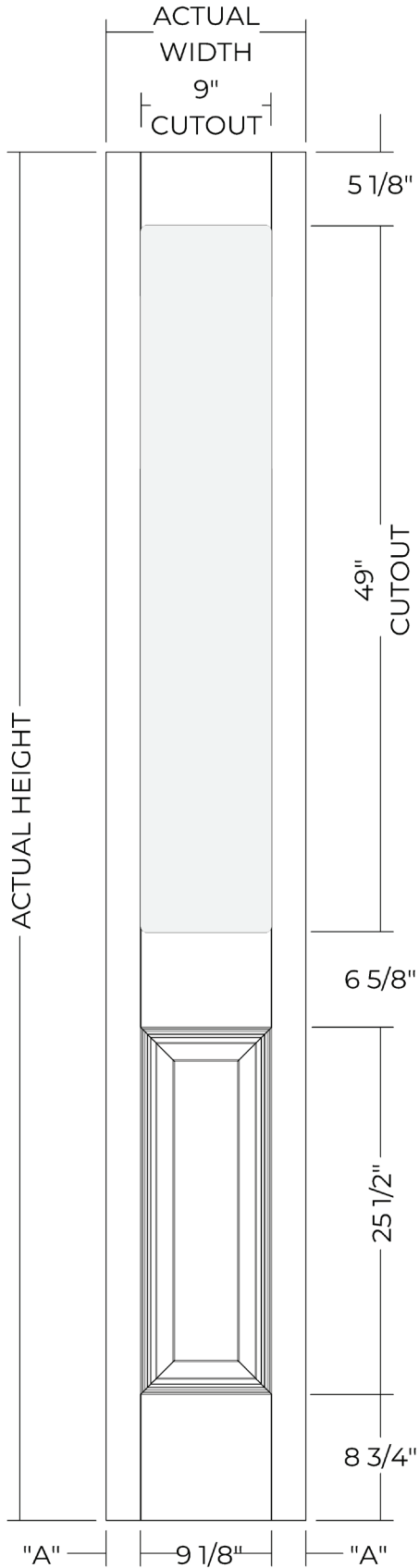

SIDELIGHT WIDTH		
NOMINAL	ACTUAL	"A"
1-0	11 7/8"	1 7/16"
1-2	13 7/8"	2 7/16"

SIDELIGHT HEIGHT	
NOMINAL	ACTUAL
8-0	95"

GLASS OPTIONS	
SIZE	CUTOUT
8 x 48	9 x 49

ESTATE

SHAKER

FIBERGLASS DOORS AND SIDELIGHTS



6'8" 1 PANEL SHAKER

FIBERGLASS DOOR

RIFT CUT | TAN

SATIN SMOOTH | WHITE

SHAKER

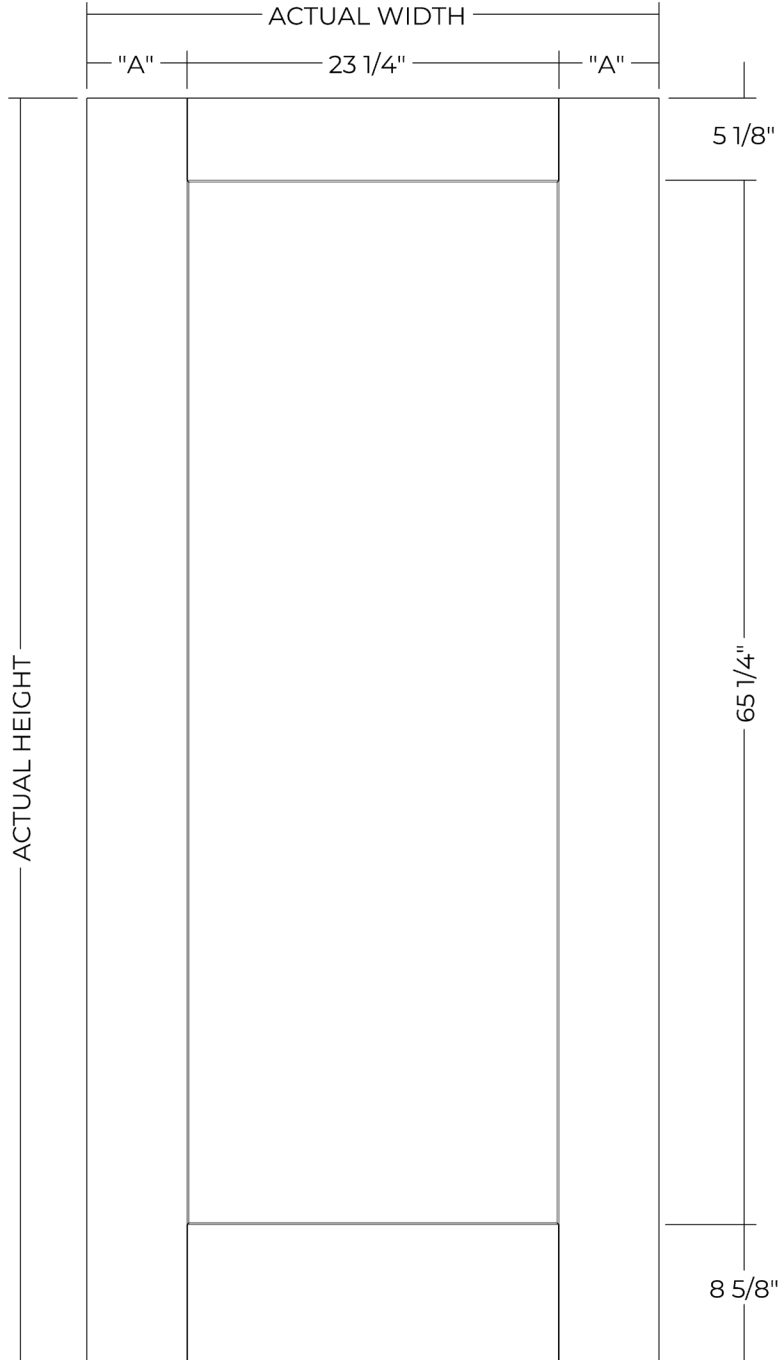

DOOR WIDTH		
NOMINAL	ACTUAL	"A"
2-8	31 3/4"	4 5/16"
2-10	33 3/4"	5 5/16"
3-0	35 3/4"	6 5/16"

DOOR HEIGHT	
NOMINAL	ACTUAL
6-8	79"

6'8" 3 PANEL CRAFTSMAN

FIBERGLASS DOOR

RIFT CUT | TAN

SATIN SMOOTH | WHITE

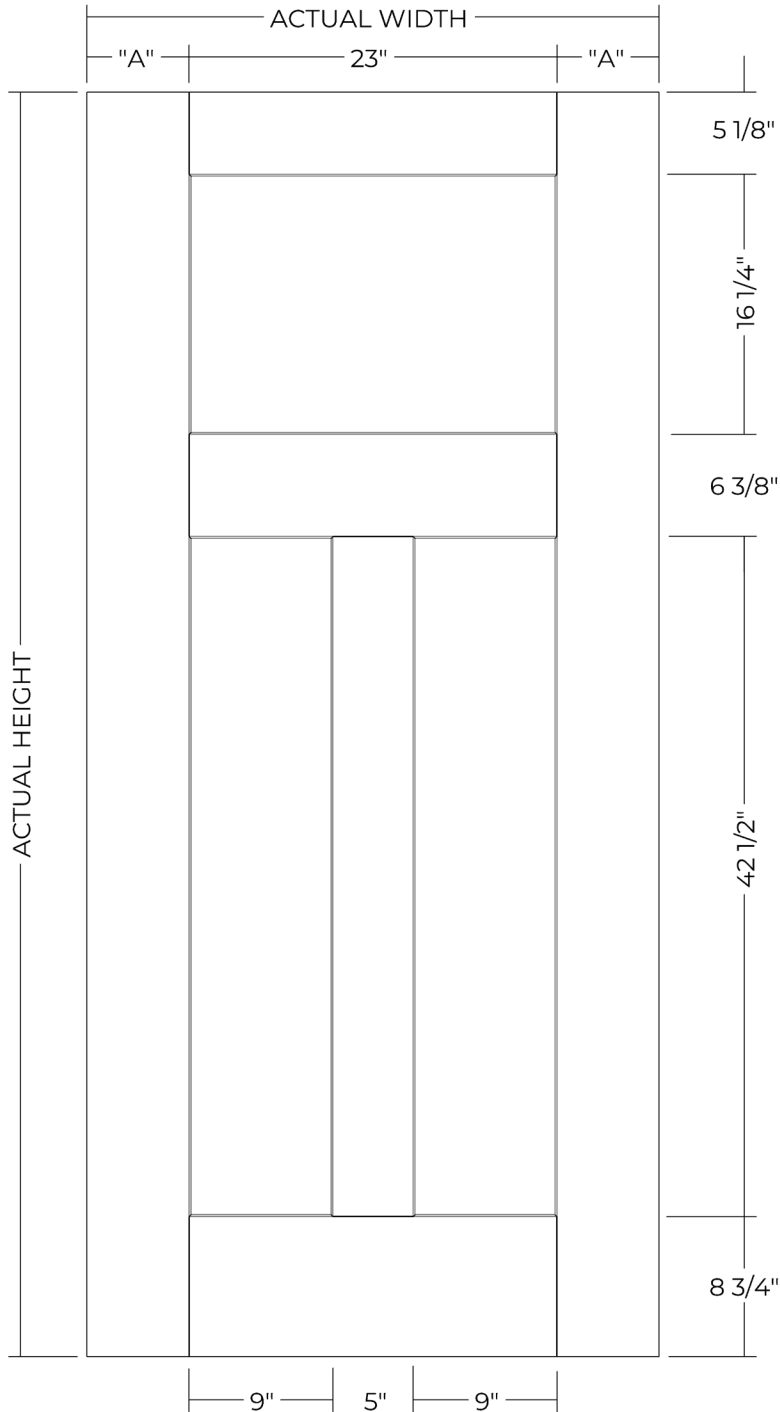

DOOR WIDTH		
NOMINAL	ACTUAL	"A"
2-8	31 3/4"	4 5/16"
2-10	33 3/4"	5 5/16"
3-0	35 3/4"	6 5/16"

DOOR HEIGHT	
NOMINAL	ACTUAL
6-8	79"

GLASS OPTIONS	
SIZE	CUTOUT
22 x 15 1/4	23 x 16 1/4
22 x 17	23 x 18
22 x 64	23 x 65



SHAKER

6'8" CRAFTSMAN

FIBERGLASS SIDELIGHT

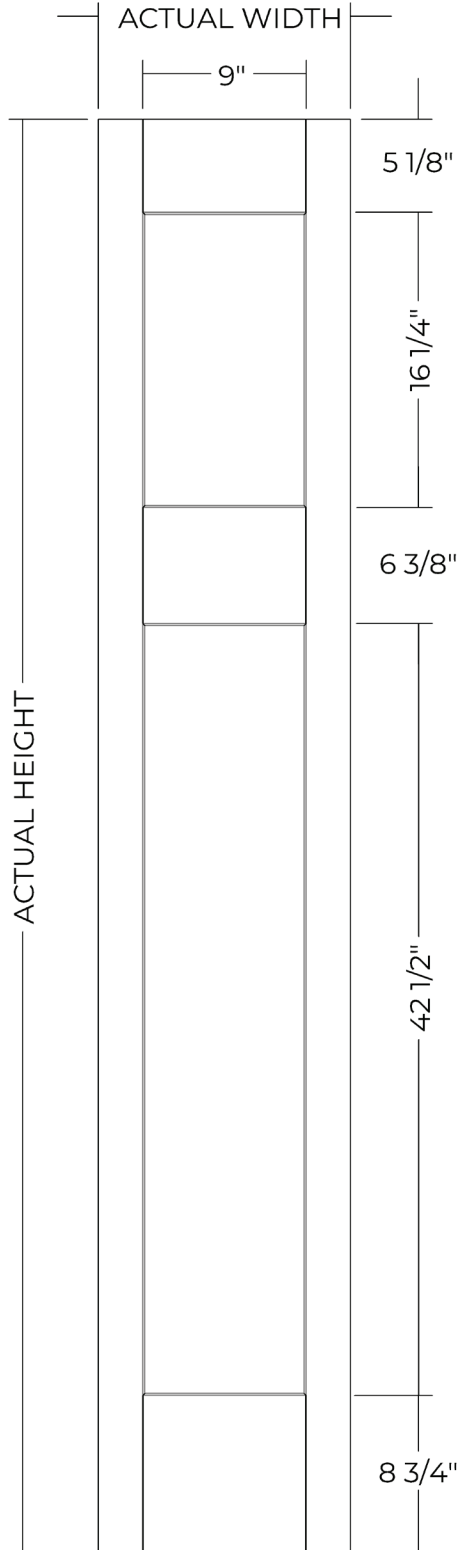

SIDELIGHT WIDTH		
NOMINAL	ACTUAL	"A"
1-0	11 7/8"	1 13/16"
1-2	13 7/8"	2 13/16"

SIDELIGHT HEIGHT	
NOMINAL	ACTUAL
6-8	79"

GLASS OPTIONS	
SIZE	CUTOUT
8 x 17	9 x 18

SHAKER

8'0" 1 PANEL SHAKER

FIBERGLASS DOOR

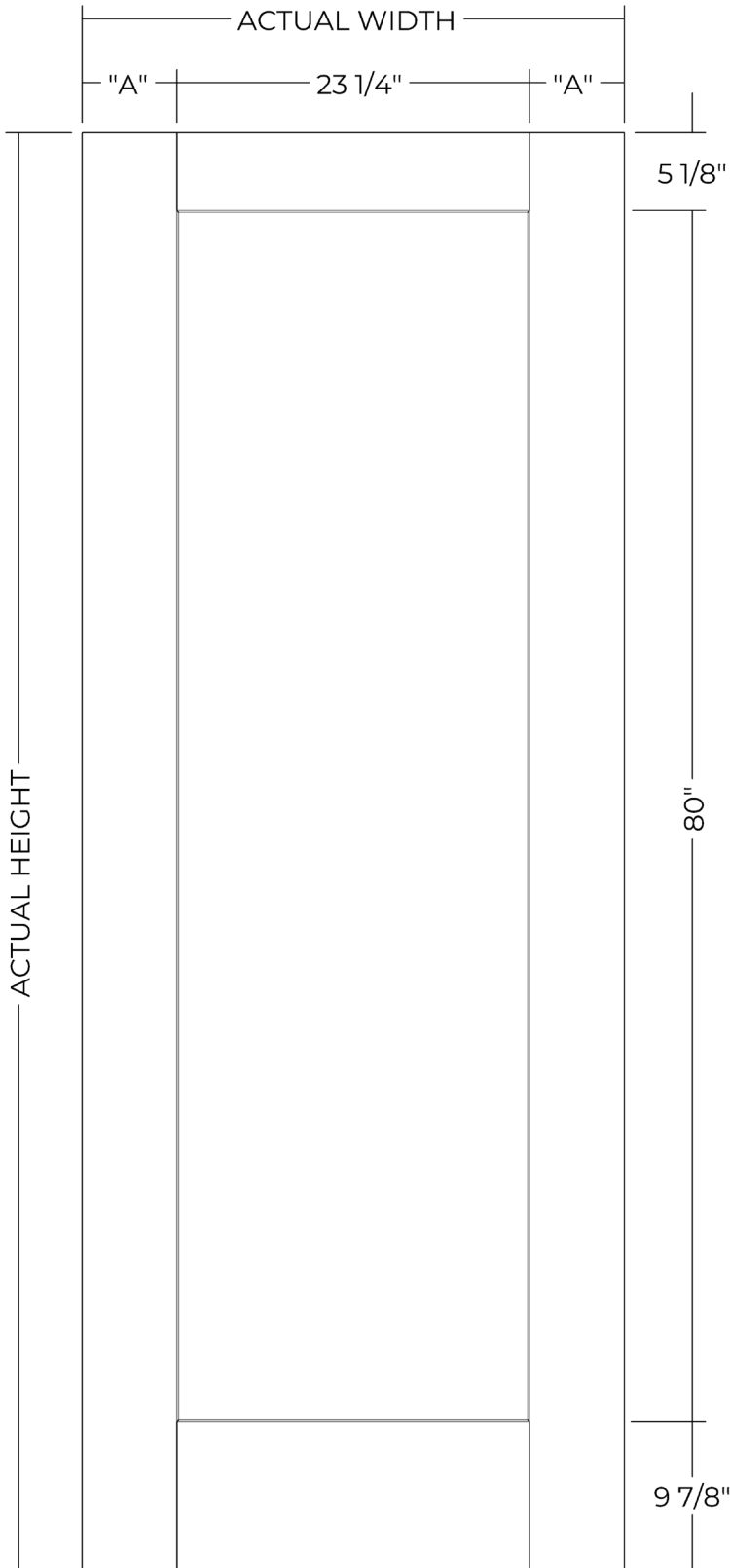

DOOR WIDTH		
NOMINAL	ACTUAL	"A"
2-8	31 3/4"	4 5/16"
2-10	33 3/4"	5 5/16"
3-0	35 3/4"	6 5/16"

DOOR HEIGHT	
NOMINAL	ACTUAL
8-0	95"

SHAKER

8'0" 3 PANEL CRAFTSMAN

FIBERGLASS DOOR

SHAKER

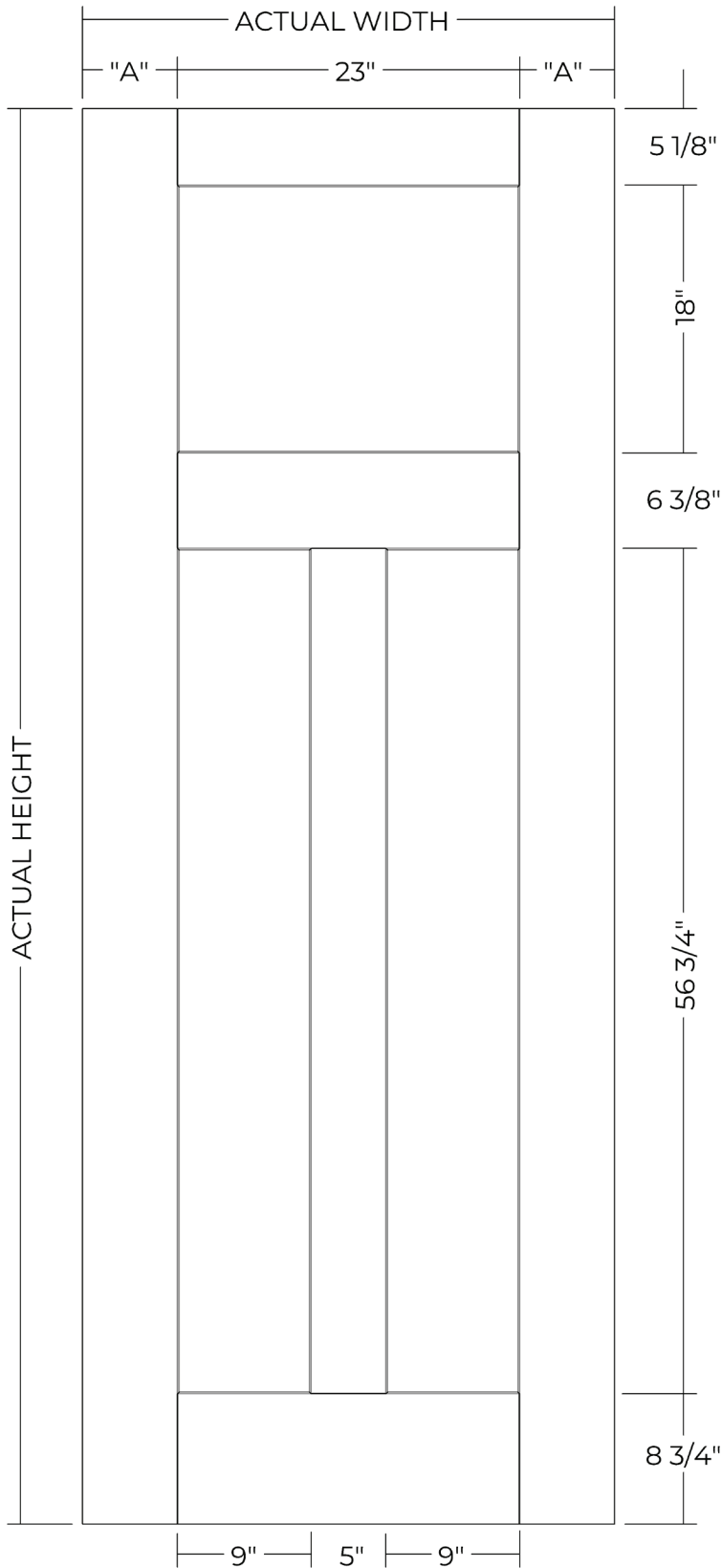

DOOR WIDTH		
NOMINAL	ACTUAL	"A"
2-8	31 3/4"	4 5/16"
2-10	33 3/4"	5 5/16"
3-0	35 3/4"	6 5/16"

DOOR HEIGHT	
NOMINAL	ACTUAL
8-0	95"

GLASS OPTIONS	
SIZE	CUTOUT
22 x 17	23 x 18
22 x 80	23 x 81

8'0" CRAFTSMAN

FIBERGLASS SIDELIGHT

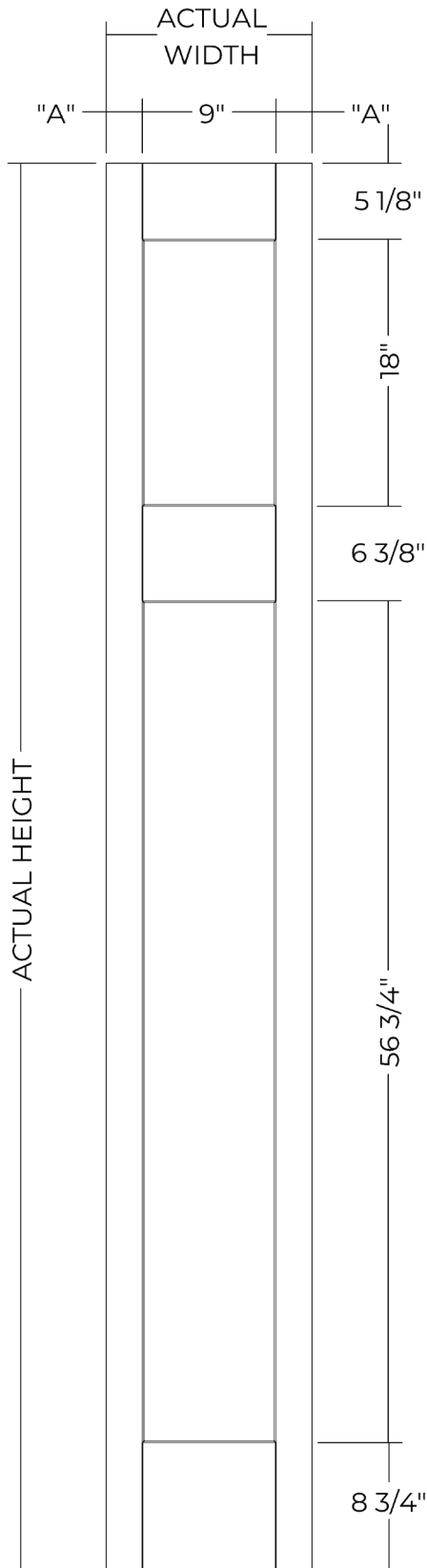

SIDELIGHT WIDTH		
NOMINAL	ACTUAL	"A"
1-0	11 7/8"	1 7/16"
1-2	13 7/8"	2 7/16"

SIDELIGHT HEIGHT	
NOMINAL	ACTUAL
8-0	95"

GLASS OPTIONS	
SIZE	CUTOUT
8 x 17	9 x 18
8 x 80	9 x 81

SHAKER

CONTEMPORARY

FIBERGLASS DOORS



6'8" CONTEMPORARY 05

FIBERGLASS DOOR

FINE GRAIN | TAN

SATIN SMOOTH | WHITE

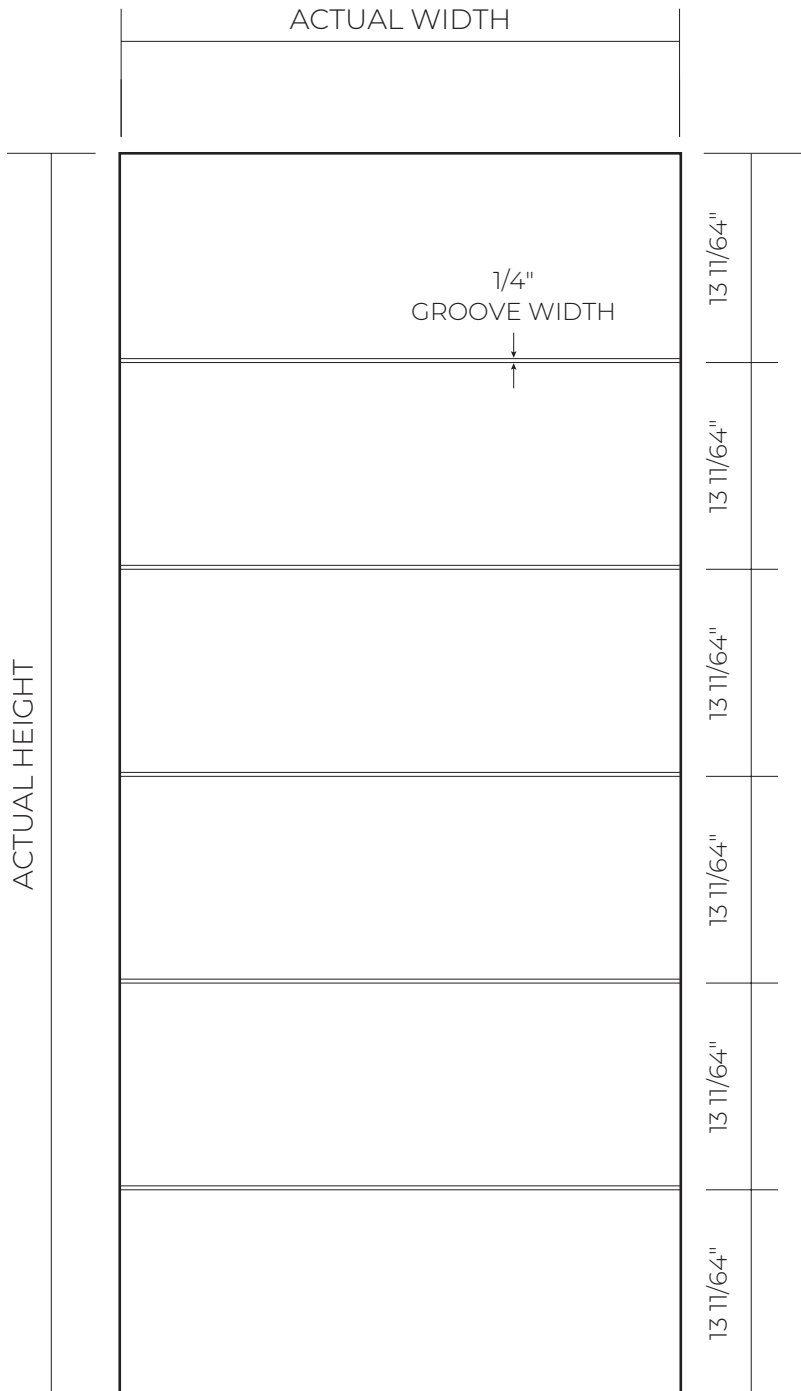

DOOR WIDTH

NOMINAL	ACTUAL
2-8	31 3/4"
2-10	33 3/4"
3-0	35 3/4"
3-6	41 3/4"

DOOR HEIGHT

NOMINAL	ACTUAL
6-8	79"

CONTEMPORARY

6'8" CONTEMPORARY 12

FIBERGLASS DOOR

FINE GRAIN | TAN

SATIN SMOOTH | WHITE

CONTEMPORARY
ACTUAL HEIGHT

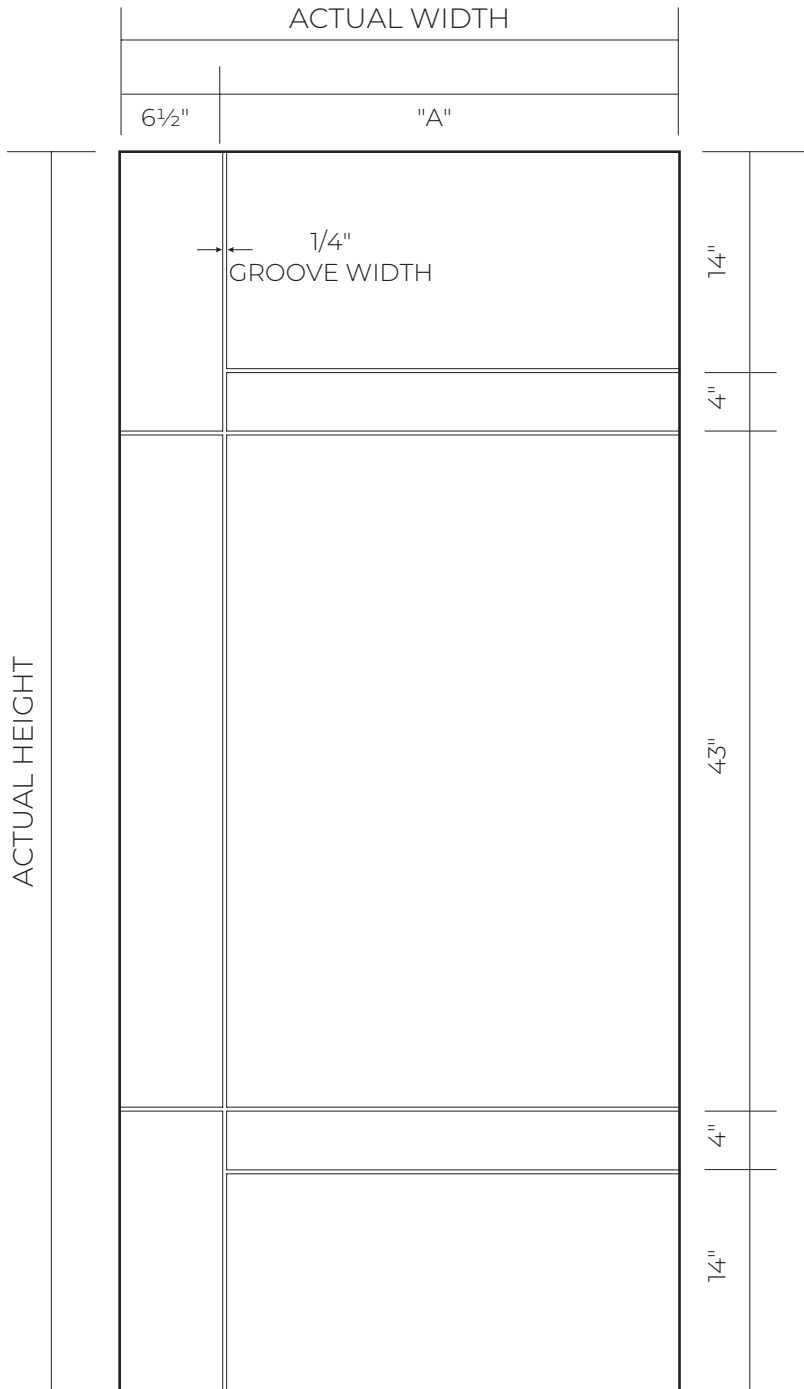

DOOR WIDTH		
NOMINAL	ACTUAL	"A"
2-8	31 3/4"	25 1/4"
2-10	33 3/4"	27 1/4"
3-0	35 3/4"	29 1/4"
3-6	41 3/4"	35 1/4"

DOOR HEIGHT	
NOMINAL	ACTUAL
6-8	79"

6'8" CONTEMPORARY 14

FIBERGLASS DOOR

FINE GRAIN | TAN

SATIN SMOOTH | WHITE

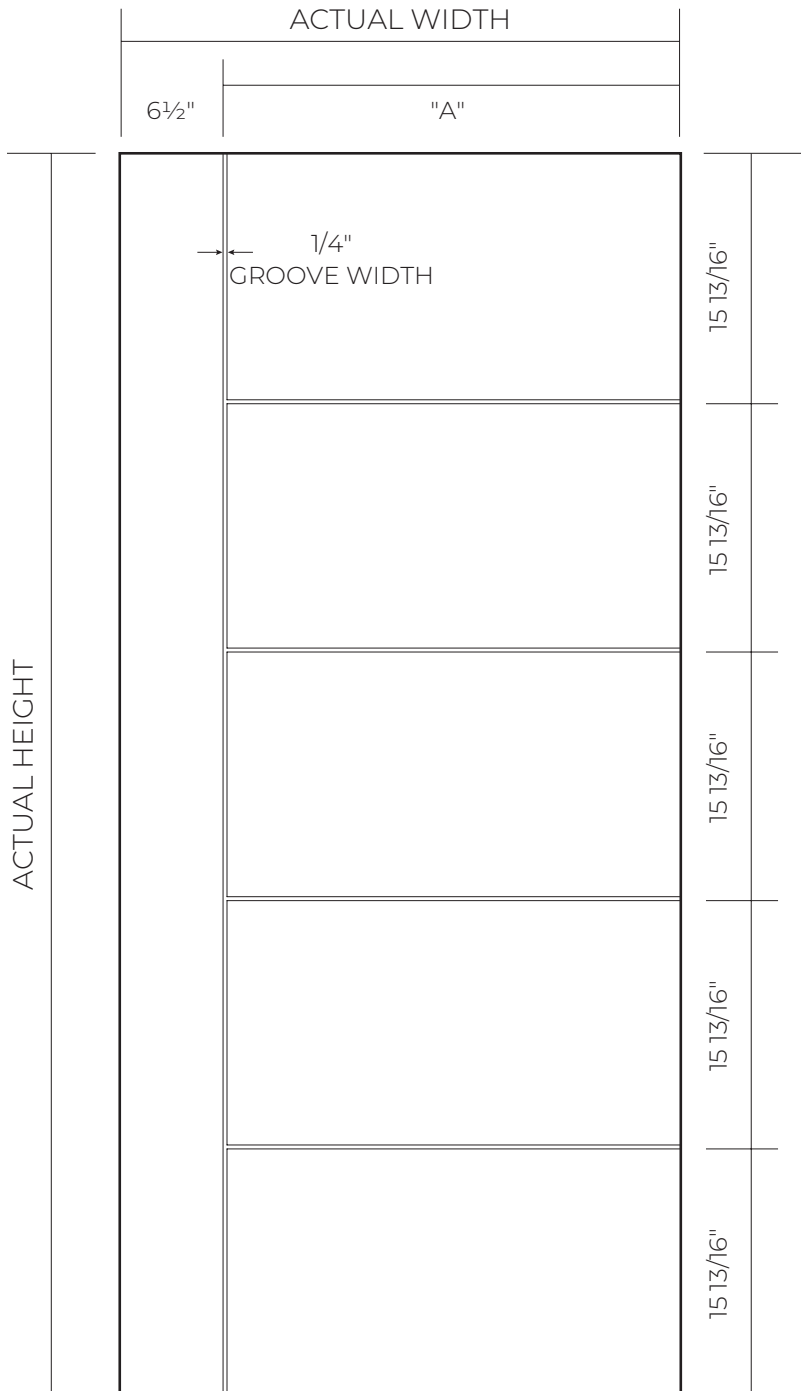

DOOR WIDTH		
NOMINAL	ACTUAL	"A"
2-8	31 3/4"	25 1/4"
2-10	33 3/4"	27 1/4"
3-0	35 3/4"	29 1/4"
3-6	41 3/4"	35 1/4"

DOOR HEIGHT	
NOMINAL	ACTUAL
6-8	79"

CONTEMPORARY

6'8" CONTEMPORARY 16

FIBERGLASS DOOR

FINE GRAIN | TAN

SATIN SMOOTH | WHITE

CONTEMPORARY
ACTUAL HEIGHT

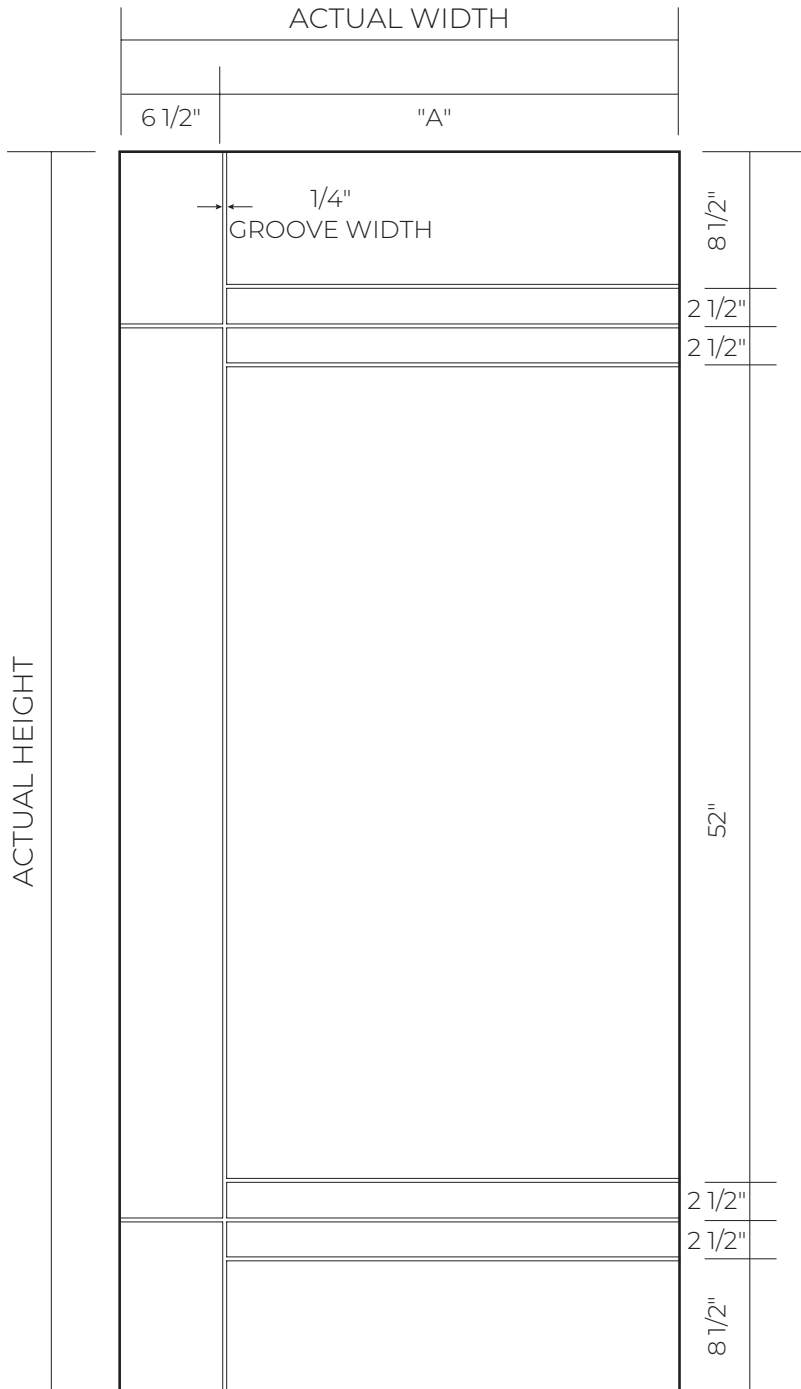

DOOR WIDTH		
NOMINAL	ACTUAL	"A"
2-8	31 3/4"	25 1/4"
2-10	33 3/4"	27 1/4"
3-0	35 3/4"	29 1/4"
3-6	41 3/4"	35 1/4"

DOOR HEIGHT	
NOMINAL	ACTUAL
6-8	79"

6'8" CONTEMPORARY 24

FIBERGLASS DOOR

FINE GRAIN | TAN

SATIN SMOOTH | WHITE

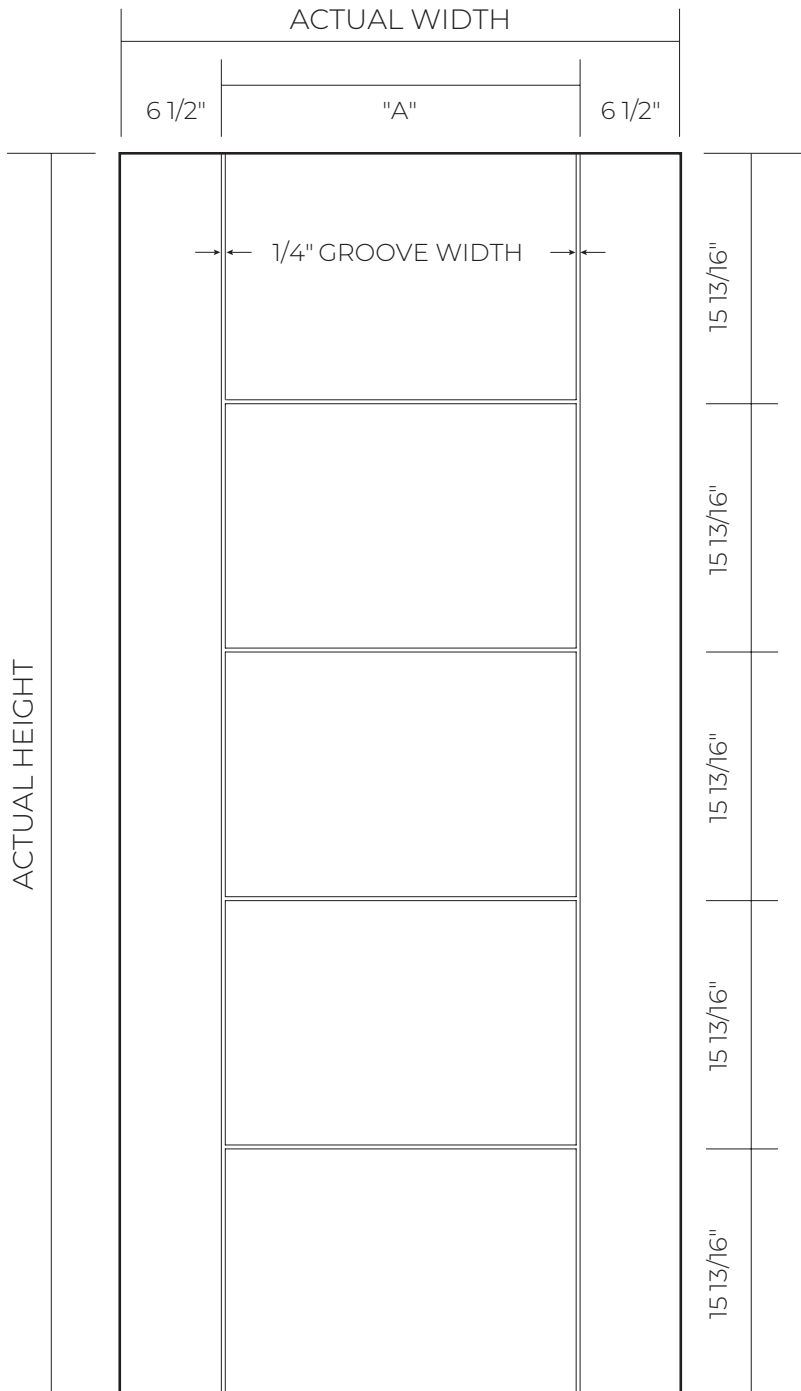

DOOR WIDTH		
NOMINAL	ACTUAL	"A"
2-8	31 3/4"	18 3/4"
2-10	33 3/4"	20 3/4"
3-0	35 3/4"	22 3/4"
3-6	41 3/4"	28 3/4"

DOOR HEIGHT	
NOMINAL	ACTUAL
6-8	79"

CONTEMPORARY

6'8" CONTEMPORARY 29

FIBERGLASS DOOR

FINE GRAIN | TAN

SATIN SMOOTH | WHITE

CONTEMPORARY

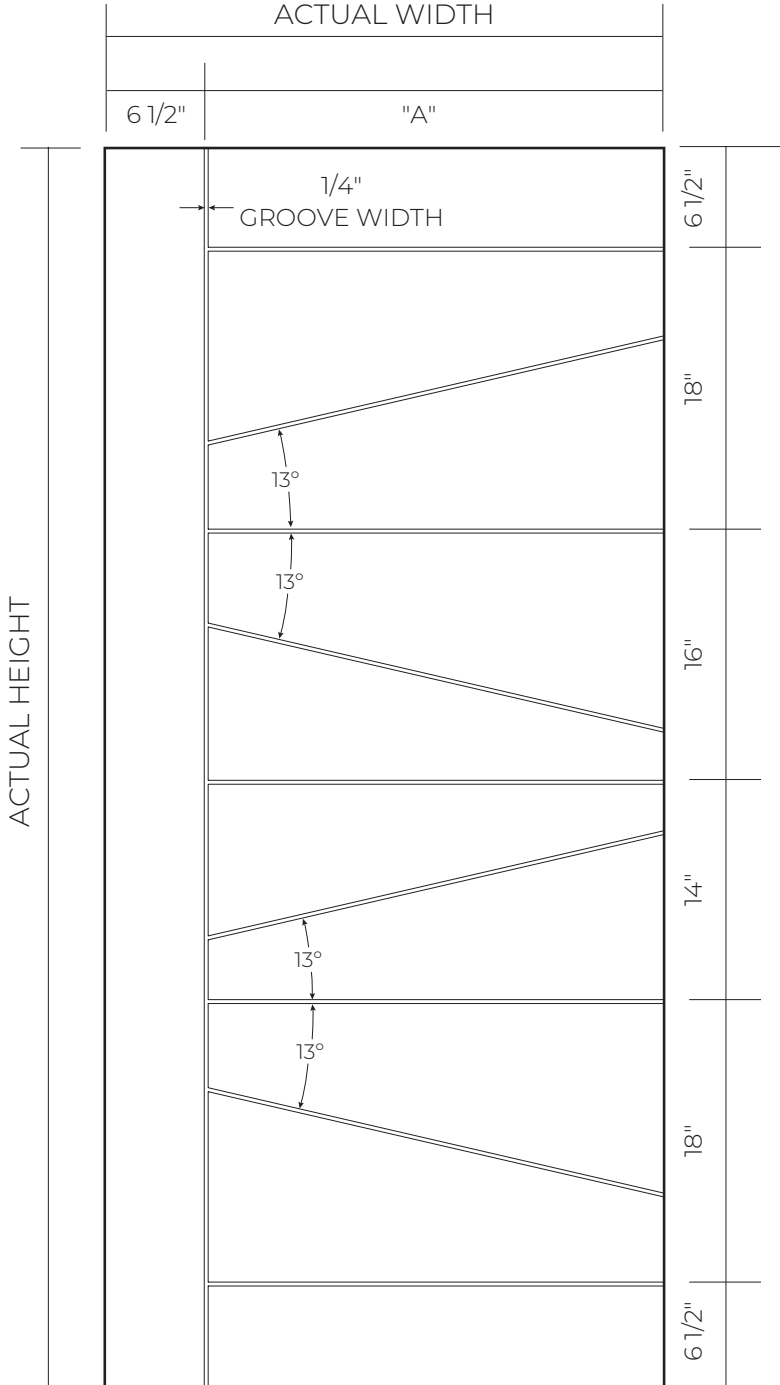

DOOR WIDTH		
NOMINAL	ACTUAL	"A"
2-8	31 3/4"	25 1/4"
2-10	33 3/4"	27 1/4"
3-0	35 3/4"	29 1/4"
3-6	41 3/4"	35 1/4"

DOOR HEIGHT	
NOMINAL	ACTUAL
6-8	79"

6'8" CONTEMPORARY 30

FIBERGLASS DOOR

FINE GRAIN | TAN

SATIN SMOOTH | WHITE

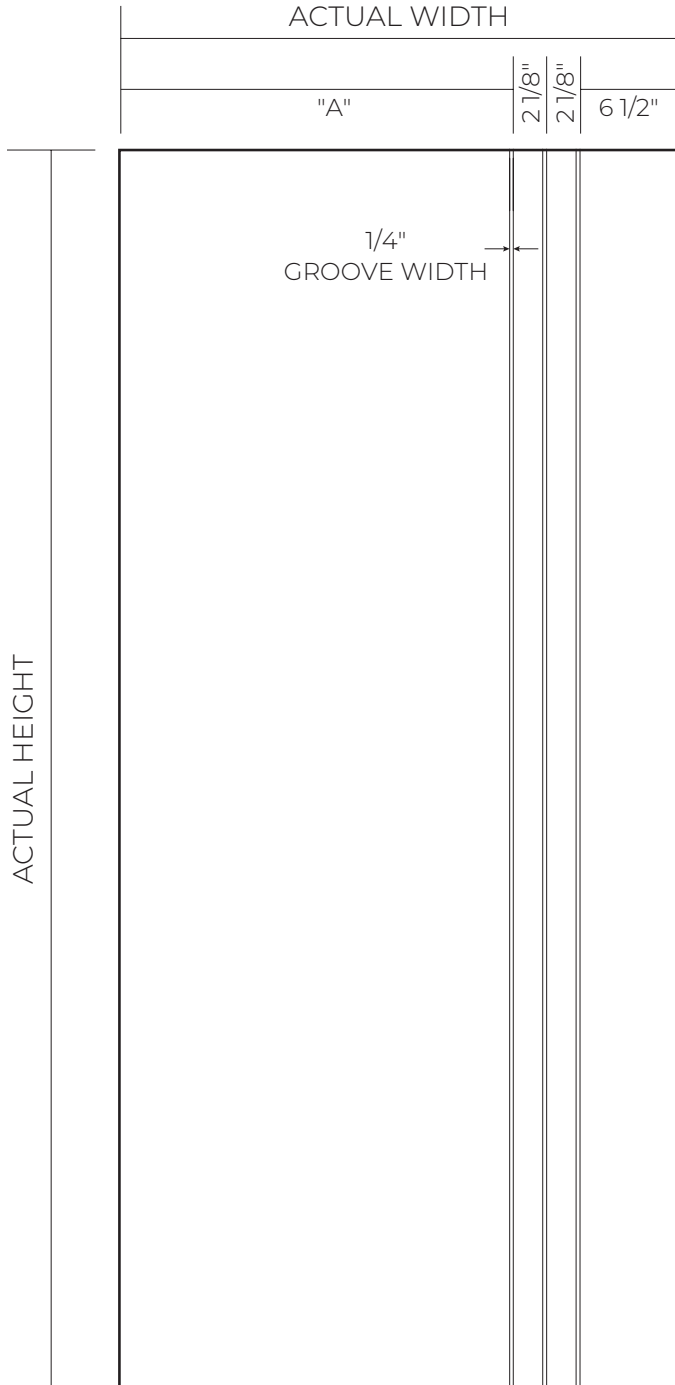

DOOR WIDTH		
NOMINAL	ACTUAL	"A"
2-8	31 3/4"	21"
2-10	33 3/4"	23"
3-0	35 3/4"	25"
3-6	41 3/4"	31"

DOOR HEIGHT	
NOMINAL	ACTUAL
6-8	79"

CONTEMPORARY

6'8" CONTEMPORARY 60

FIBERGLASS DOOR

FINE GRAIN | TAN

SATIN SMOOTH | WHITE

CONTEMPORARY

ACTUAL HEIGHT

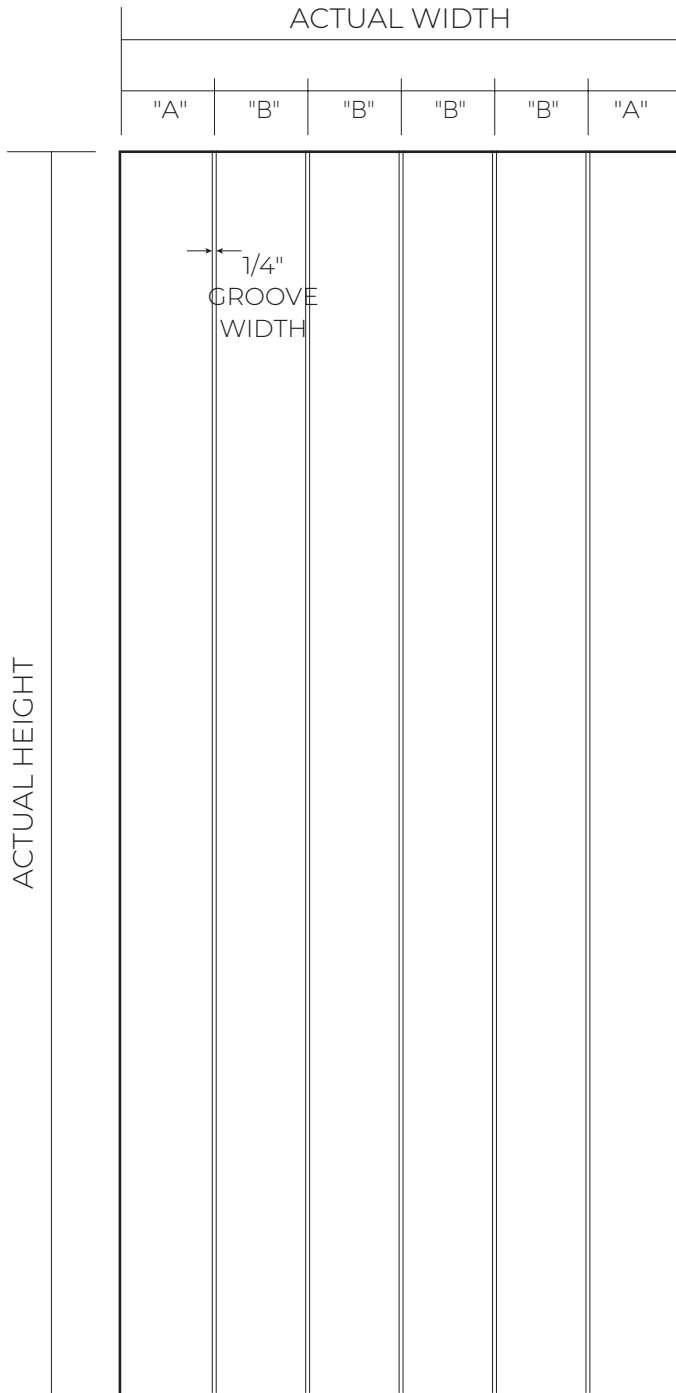

DOOR WIDTH

NOMINAL	ACTUAL	"A"	"B"
2-8	31 3/4"	5 3/8"	5 1/4"
2-10	33 3/4"	5 5/8"	5 5/8"
3-0	35 3/4"	6"	5 15/16"
3-6	41 3/4"	7"	6 15/16"

DOOR HEIGHT

NOMINAL	ACTUAL
6-8	79"

8'0" CONTEMPORARY 05

FIBERGLASS DOOR

FINE GRAIN | TAN

SATIN SMOOTH | WHITE

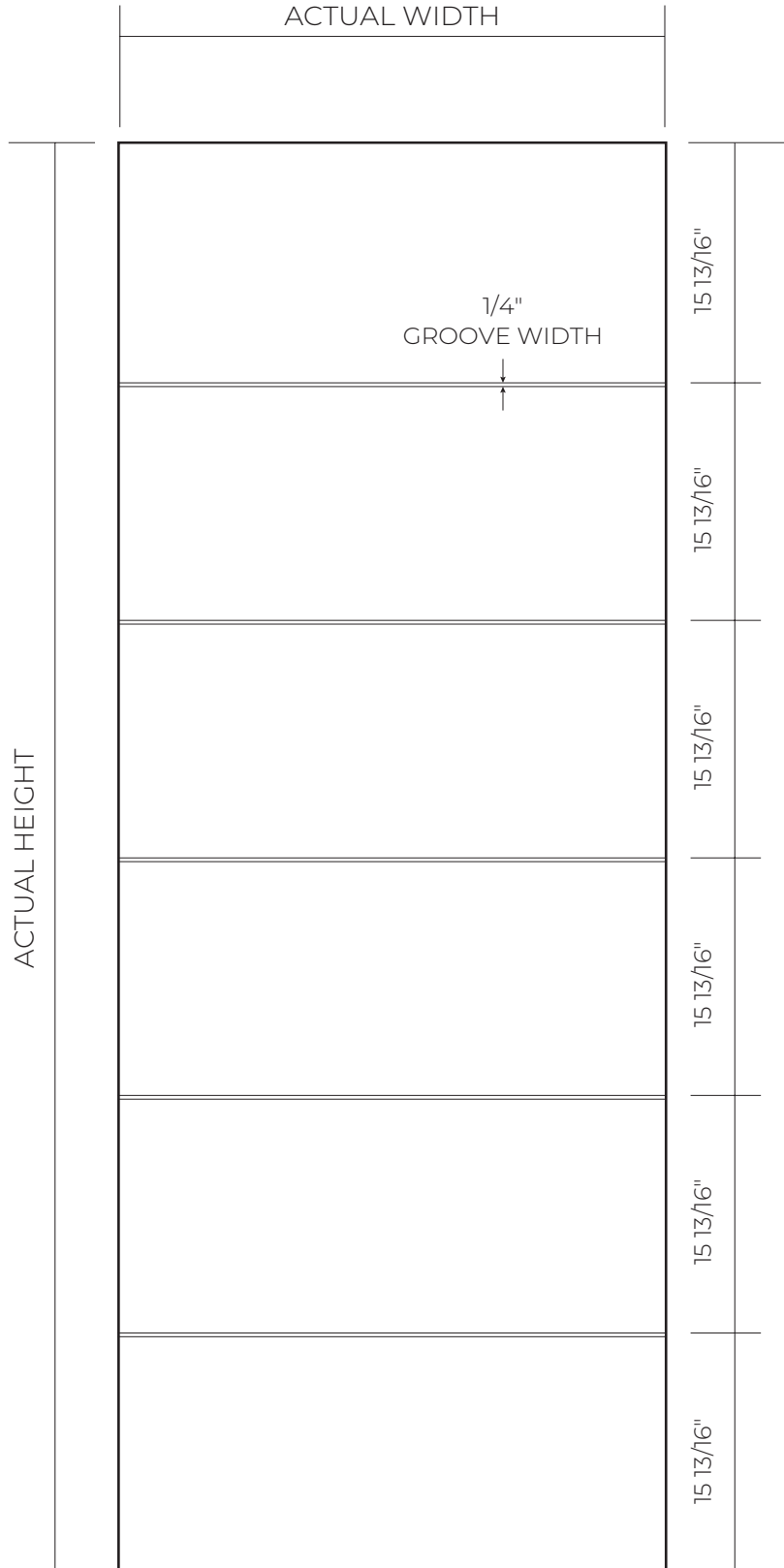

DOOR WIDTH	
NOMINAL	ACTUAL
2-8	31 3/4"
2-10	33 3/4"
3-0	35 3/4"
3-6	41 3/4"

DOOR HEIGHT	
NOMINAL	ACTUAL
8-0	95"

CONTEMPORARY

8'0" CONTEMPORARY 12

FIBERGLASS DOOR

FINE GRAIN | TAN

SATIN SMOOTH | WHITE

CONTEMPORARY

ACTUAL HEIGHT

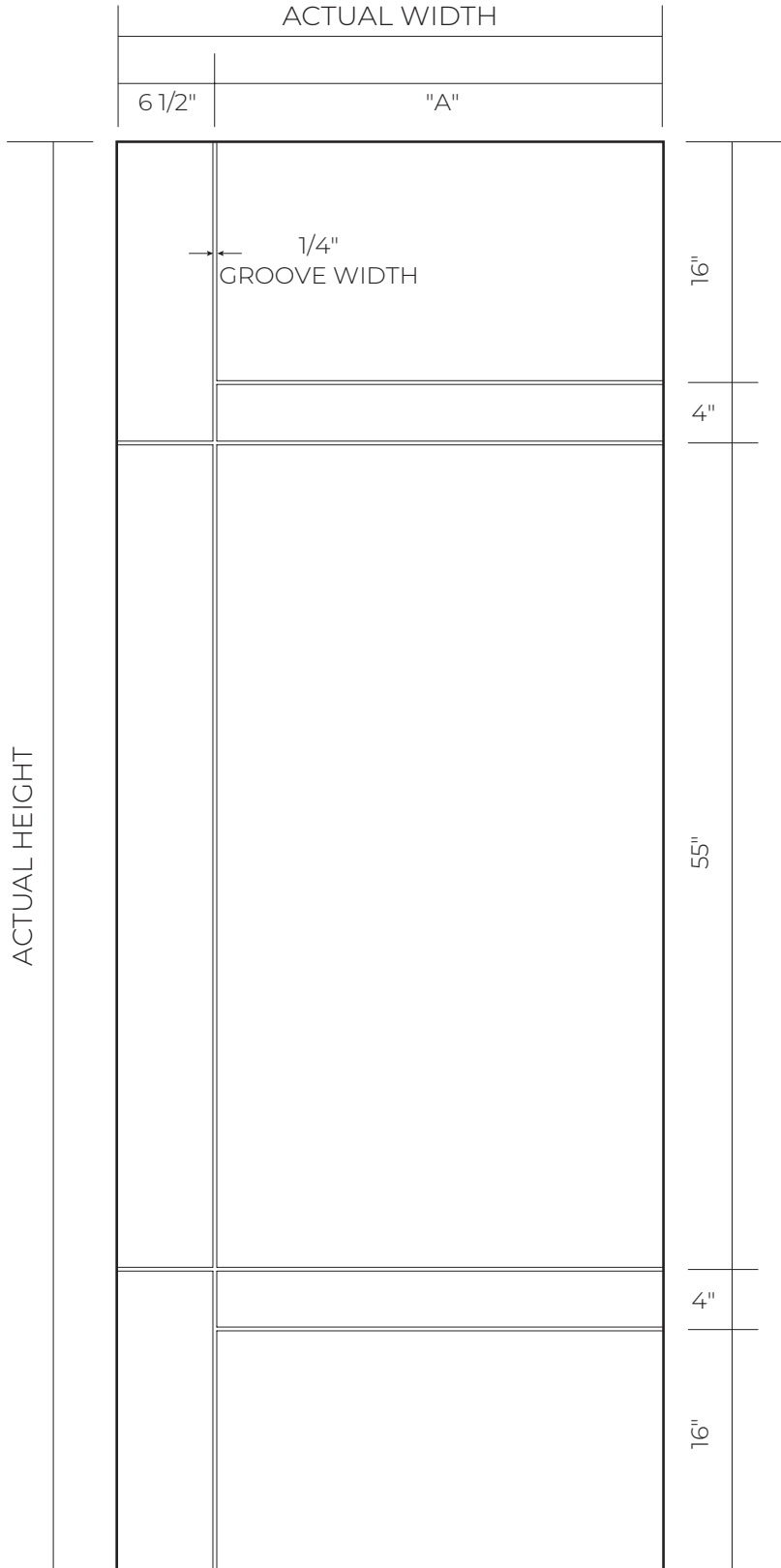

DOOR WIDTH

NOMINAL	ACTUAL	"A"
2-8	31 3/4"	25 1/4"
2-10	33 3/4"	27 1/4"
3-0	35 3/4"	29 1/4"
3-6	41 3/4"	35 1/4"

DOOR HEIGHT

NOMINAL	ACTUAL
8-0	95"

8'0" CONTEMPORARY 14

FIBERGLASS DOOR

FINE GRAIN | TAN

SATIN SMOOTH | WHITE

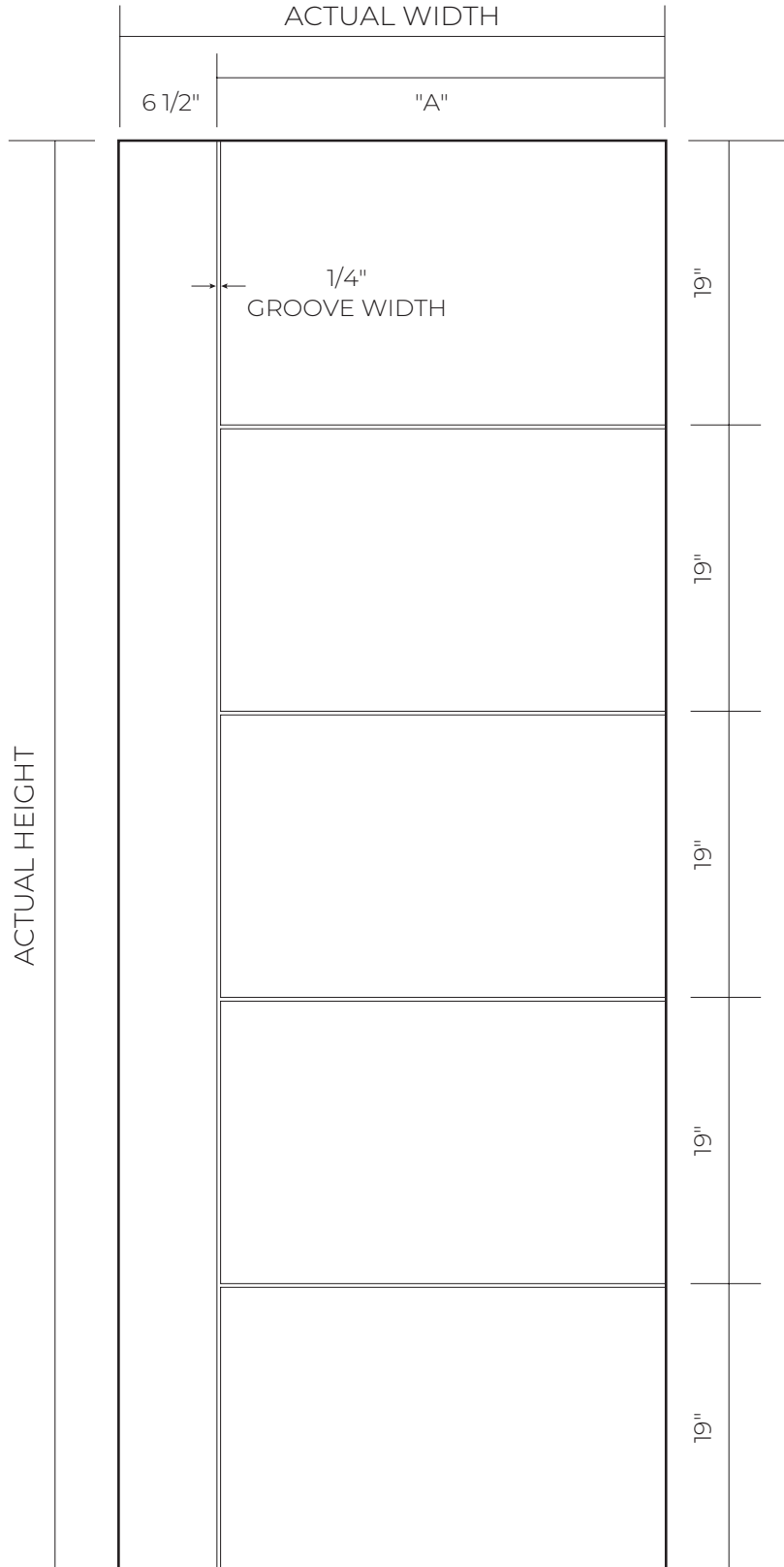

DOOR WIDTH		
NOMINAL	ACTUAL	"A"
2-8	31 3/4"	25 1/4"
2-10	33 3/4"	27 1/4"
3-0	35 3/4"	29 1/4"
3-6	41 3/4"	35 1/4"

DOOR HEIGHT	
NOMINAL	ACTUAL
8-0	95"

ACTUAL HEIGHT

CONTEMPORARY

8'0" CONTEMPORARY 16

FIBERGLASS DOOR

FINE GRAIN | TAN

SATIN SMOOTH | WHITE

CONTEMPORARY

ACTUAL HEIGHT

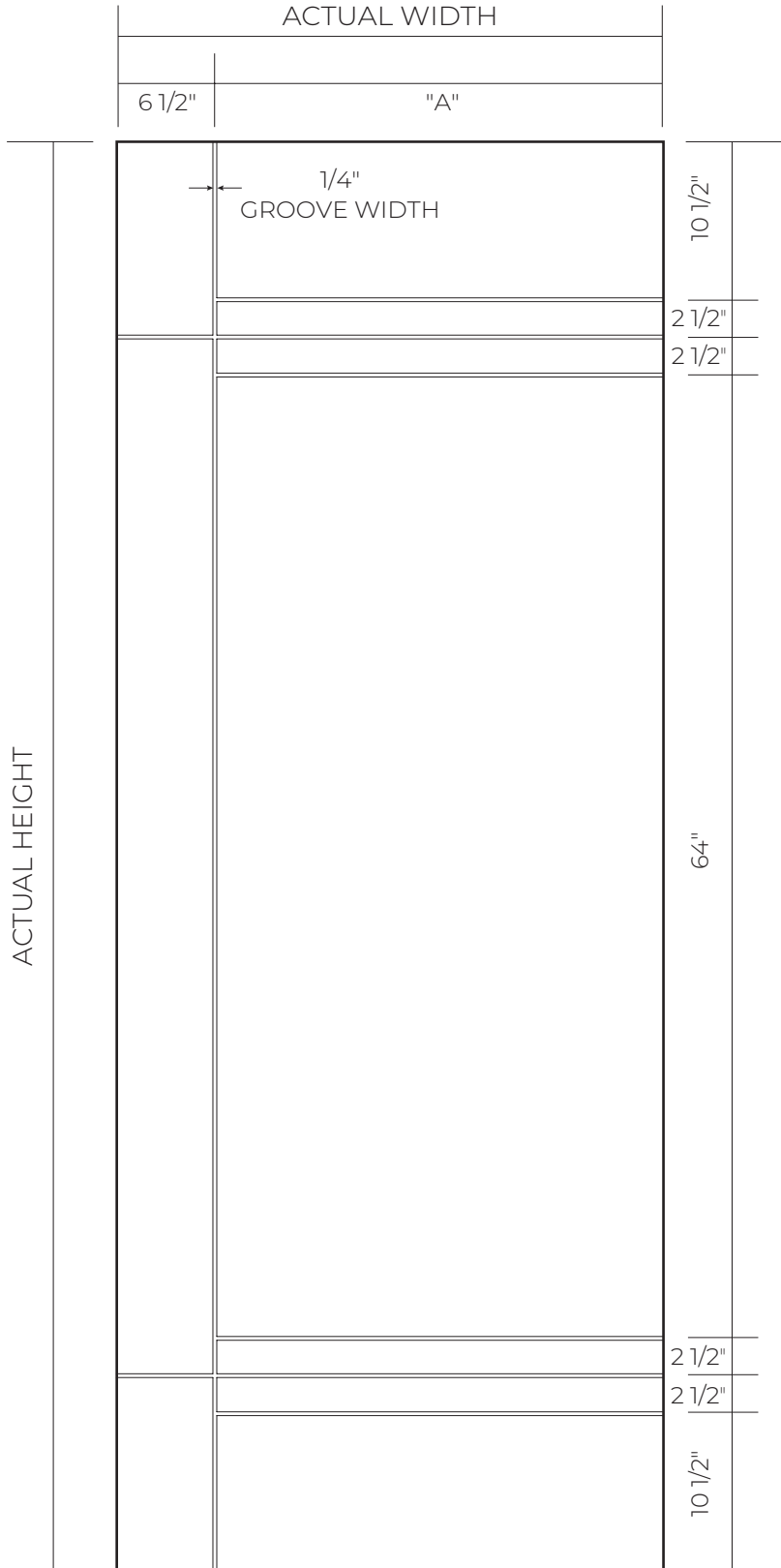

DOOR WIDTH

NOMINAL	ACTUAL	"A"
2-8	31 3/4"	25 1/4"
2-10	33 3/4"	27 1/4"
3-0	35 3/4"	29 1/4"
3-6	41 3/4"	35 1/4"

DOOR HEIGHT

NOMINAL	ACTUAL
8-0	95"

8'0" CONTEMPORARY 24

FIBERGLASS DOOR

FINE GRAIN | TAN

SATIN SMOOTH | WHITE

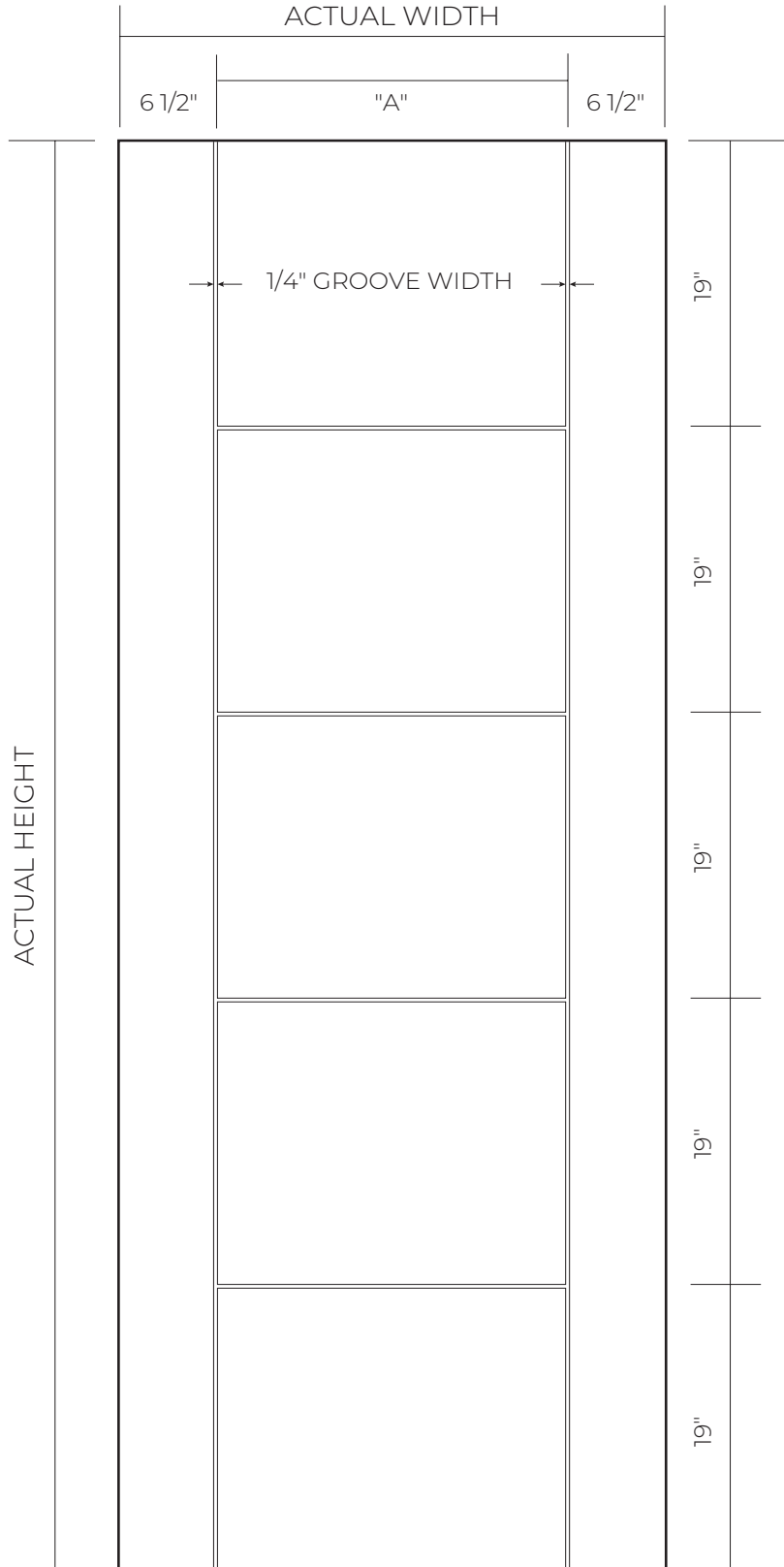

DOOR WIDTH		
NOMINAL	ACTUAL	"A"
2-8	31 3/4"	18 3/4"
2-10	33 3/4"	20 3/4"
3-0	35 3/4"	22 3/4"
3-6	41 3/4"	28 3/4"

DOOR HEIGHT	
NOMINAL	ACTUAL
8-0	95"

CONTEMPORARY

8'0" CONTEMPORARY 29

FIBERGLASS DOOR

FINE GRAIN | TAN

SATIN SMOOTH | WHITE

CONTEMPORARY

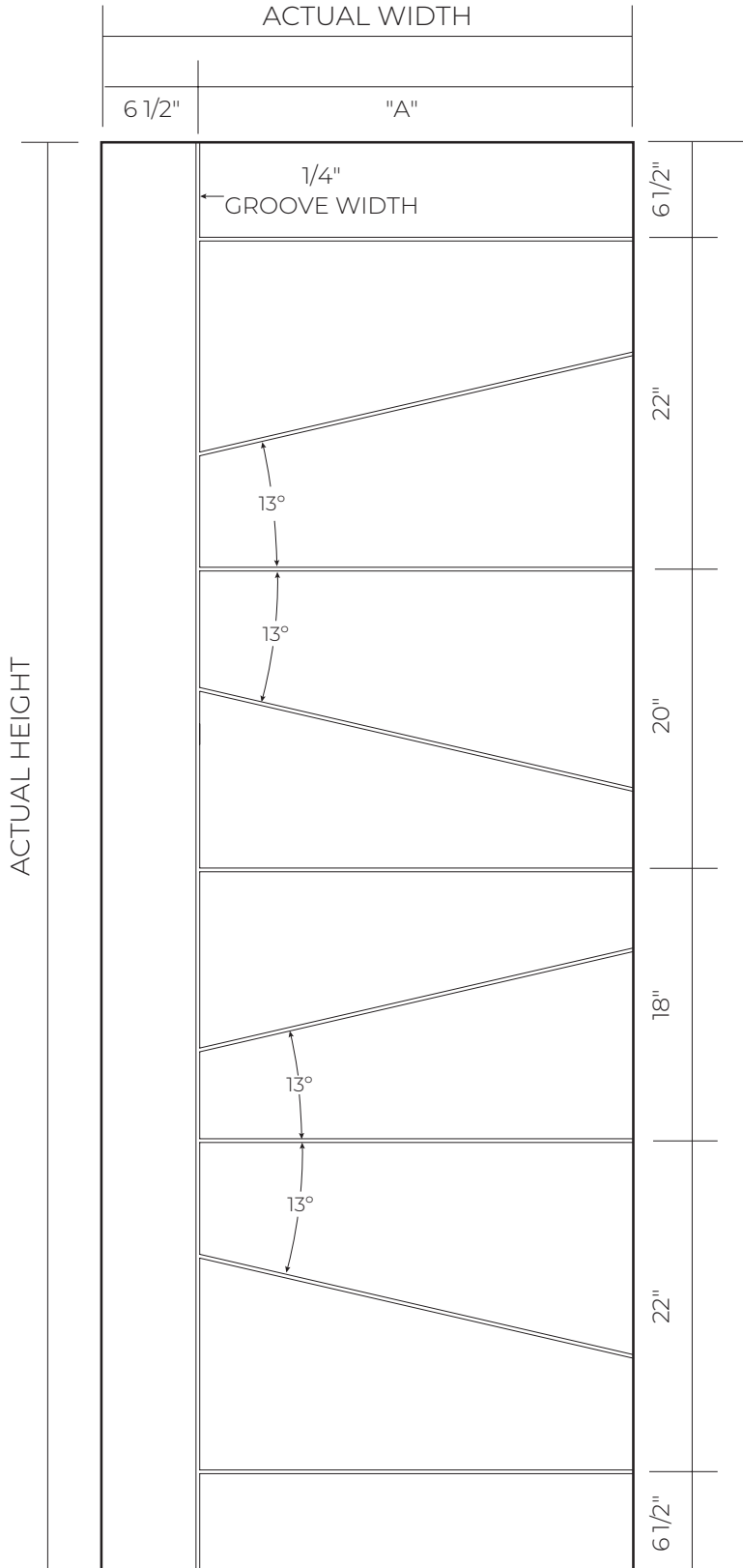

DOOR WIDTH		
NOMINAL	ACTUAL	"A"
2-8	31 3/4"	25 1/4"
2-10	33 3/4"	27 1/4"
3-0	35 3/4"	29 1/4"
3-6	41 3/4"	35 1/4"

DOOR HEIGHT	
NOMINAL	ACTUAL
8-0	95"

8'0" CONTEMPORARY 30

FIBERGLASS DOOR

FINE GRAIN | TAN

SATIN SMOOTH | WHITE

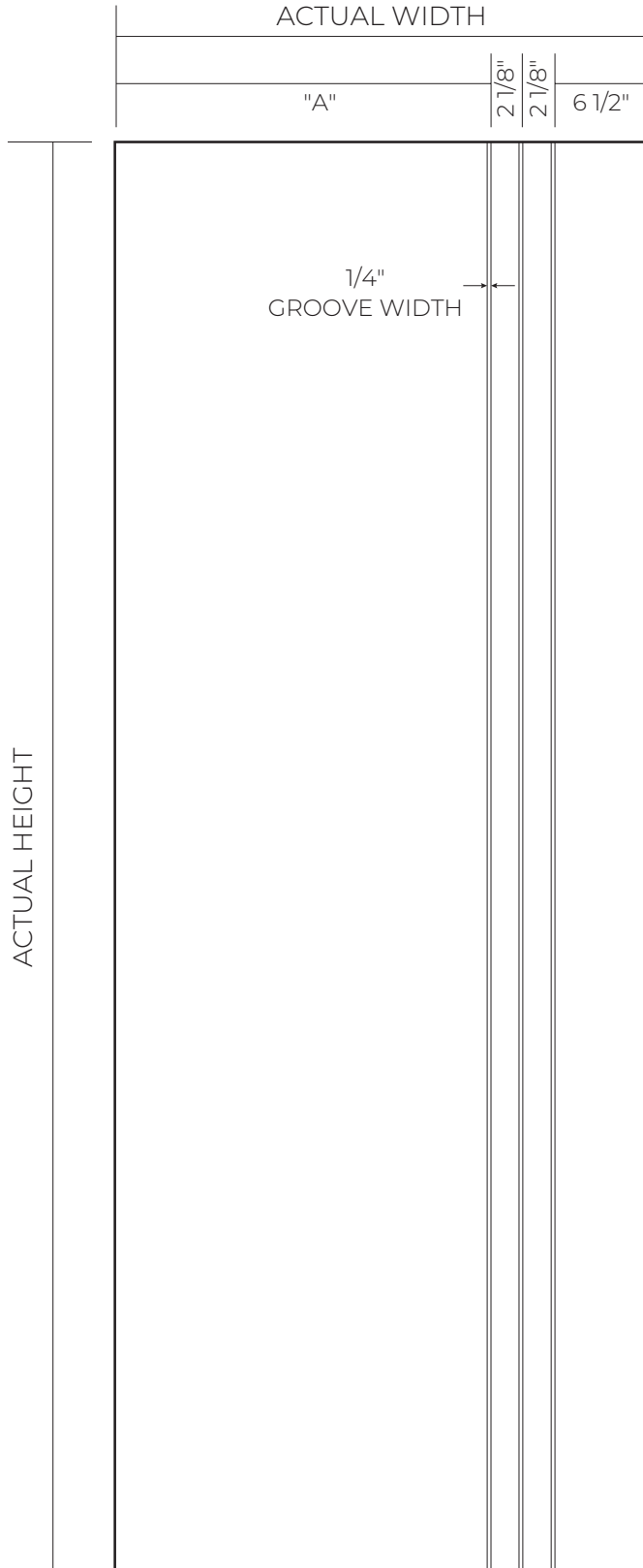

DOOR WIDTH		
NOMINAL	ACTUAL	"A"
2-8	31 3/4"	21"
2-10	33 3/4"	23"
3-0	35 3/4"	25"
3-6	41 3/4"	31"

DOOR HEIGHT	
NOMINAL	ACTUAL
8-0	95"

CONTEMPORARY

8'0" CONTEMPORARY 60

FIBERGLASS DOOR

FINE GRAIN | TAN

SATIN SMOOTH | WHITE

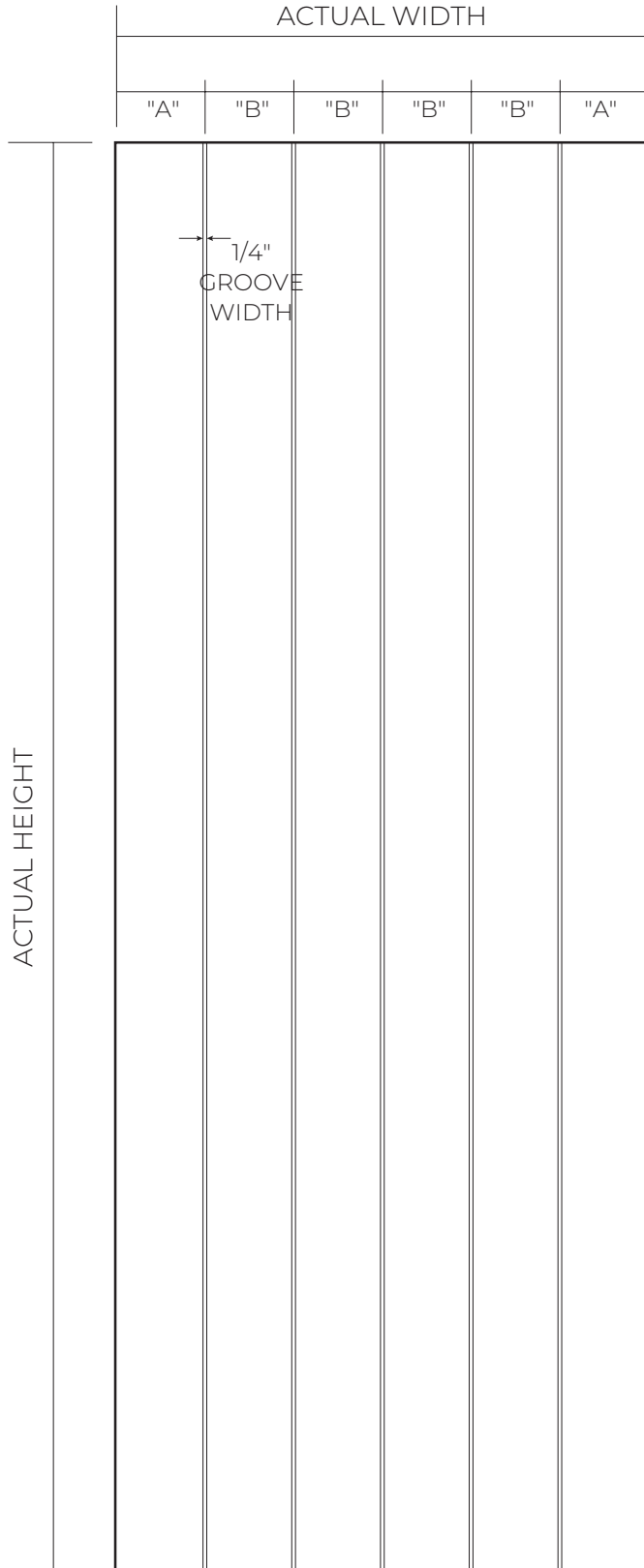

DOOR WIDTH			
NOMINAL	ACTUAL	"A"	"B"
2-8	31 3/4"	5 3/8"	5 1/4"
2-10	33 3/4"	5 5/8"	5 5/8"
3-0	35 3/4"	6"	5 15/16"
3-6	41 3/4"	7"	6 15/16"

DOOR HEIGHT	
NOMINAL	ACTUAL
8-0	95"

CONTEMPORARY

PRO OAK

FIBERGLASS DOORS AND SIDELIGHTS



6'8" FLUSH

FIBERGLASS DOOR

TAN OAK | TAN

WHITE OAK | WHITE

PRO OAK

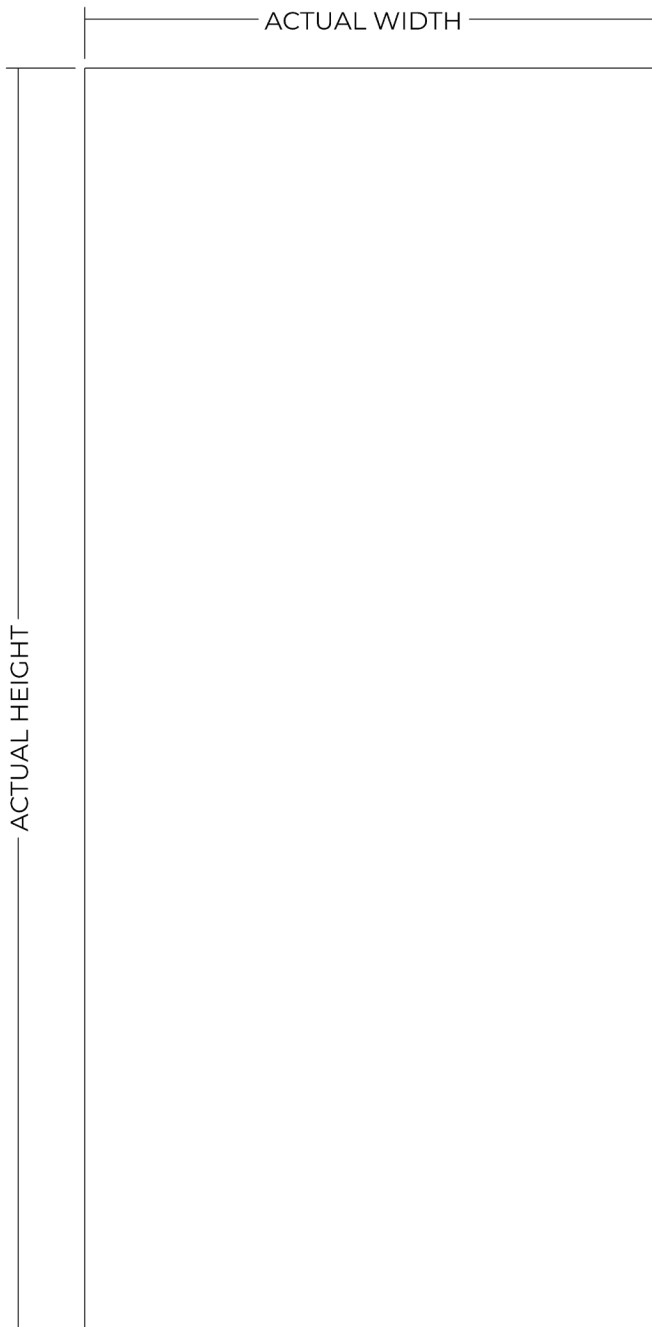

DOOR WIDTH

NOMINAL	ACTUAL
2-6	29 3/4"
2-8	31 3/4"
2-10	33 3/4"
3-0	35 3/4"
3-6	41 3/4"

DOOR HEIGHT

NOMINAL	ACTUAL
6-8	79"

GLASS OPTIONS

SIZE	CUTOUT
8 x 6	9 x 7
8 x 36	9 x 37
7 x 64	8 x 65
8 x 64	9 x 65
22 x 10	23 x 11
22 x 36	23 x 37
22 x 48	23 x 49
22 x 64	23 x 65
22 x 17	23 x 18



ADA COMPLIANT

6'8" 6 PANEL

FIBERGLASS DOOR

TAN OAK | TAN

WHITE OAK | WHITE

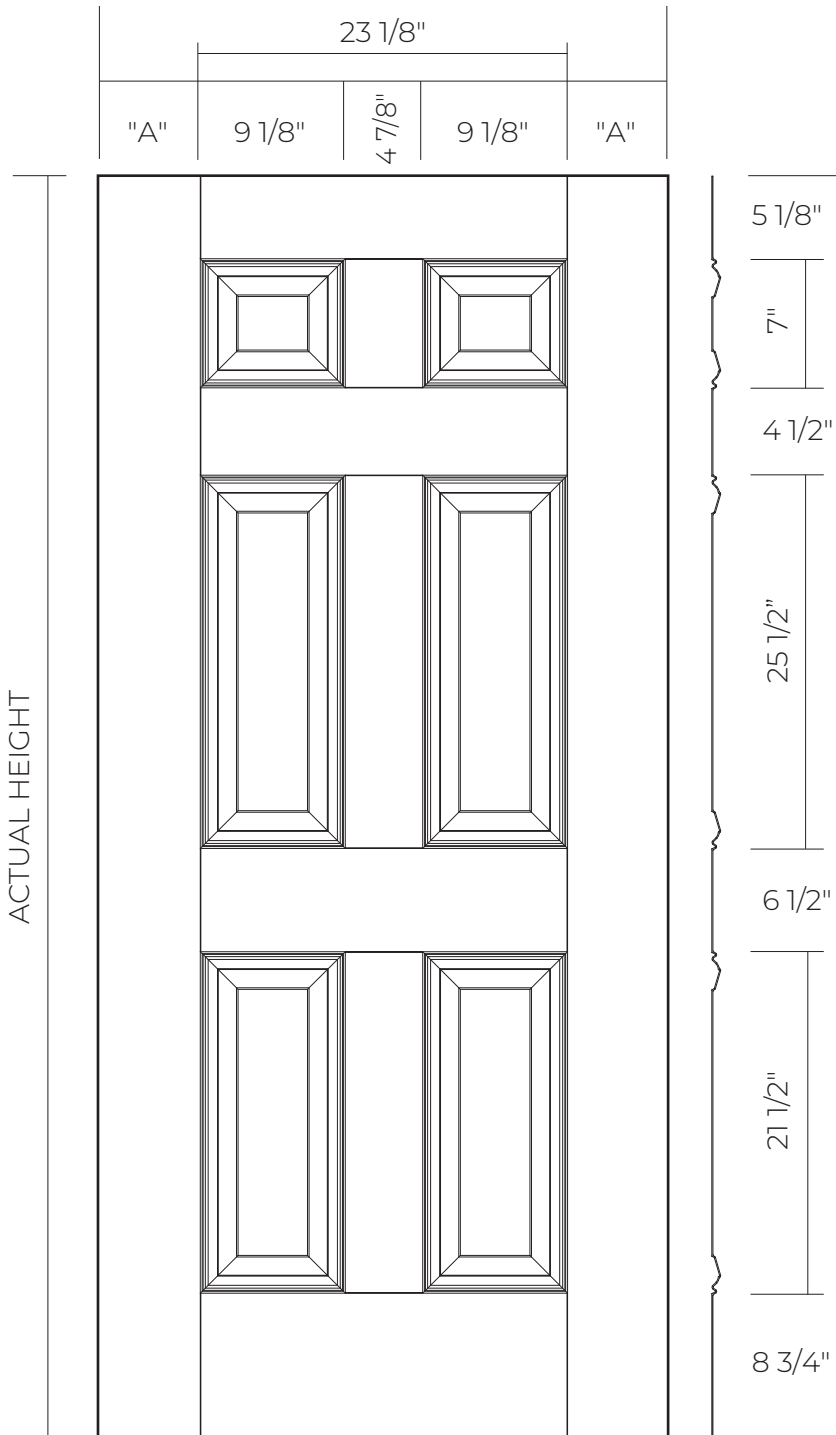

DOOR WIDTH		
NOMINAL	ACTUAL	"A"
2-8	31 3/4"	4 5/16"
2-10	33 3/4"	5 5/16"
3-0	35 3/4"	6 5/16"

DOOR HEIGHT	
NOMINAL	ACTUAL
6-8	79"

GLASS OPTIONS	
SIZE	CUTOUT
22 x 10	23 x 11
22 x 36	23 x 37
22 x 64	23 x 65



PRO OAK

6'8" 6 PANEL NARROW

FIBERGLASS DOOR

TAN OAK | TAN

WHITE OAK | WHITE

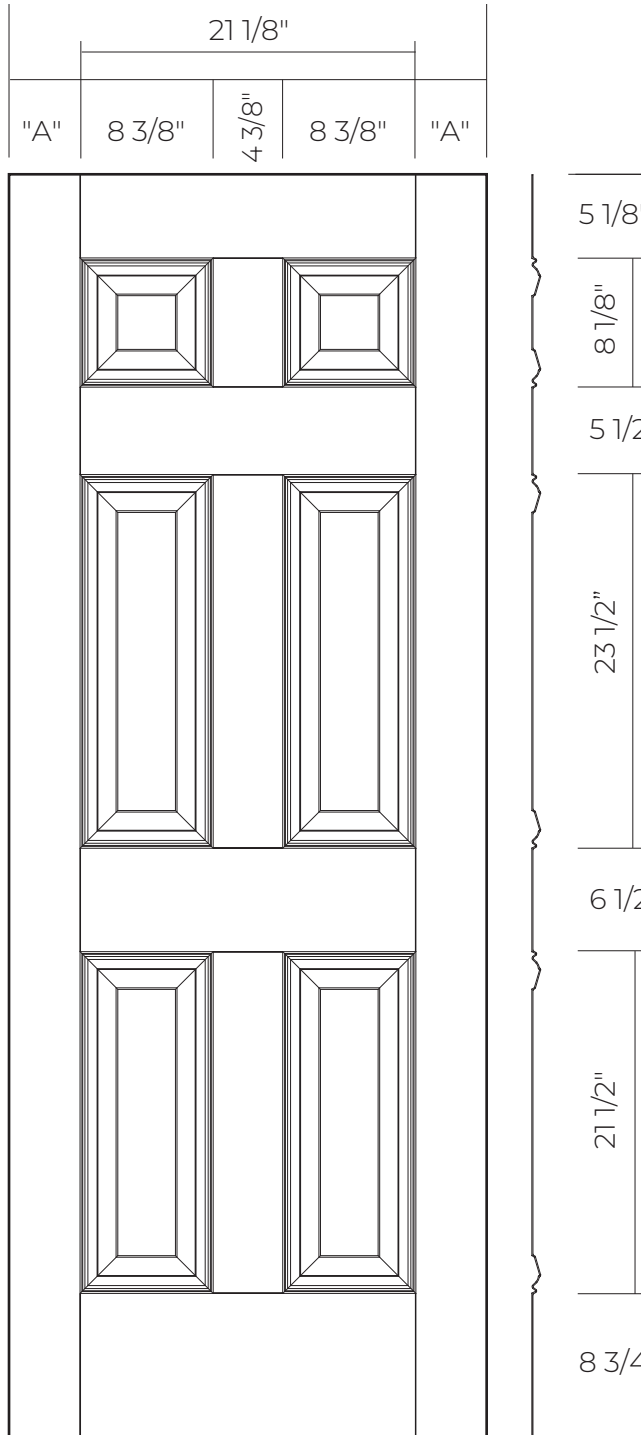

DOOR WIDTH

NOMINAL	ACTUAL	"A"
2-6*	29 3/4"	4 5/16"

DOOR HEIGHT

NOMINAL	ACTUAL
6-8	79"

GLASS OPTIONS

SIZE	CUTOUT
20 x 36	21 x 37
20 x 64	21 x 65

* 2 3/8" Backset Only

PRO OAK

6'8" 4 PANEL BLANK TOP

FIBERGLASS DOOR

TAN OAK | TAN

WHITE OAK | WHITE

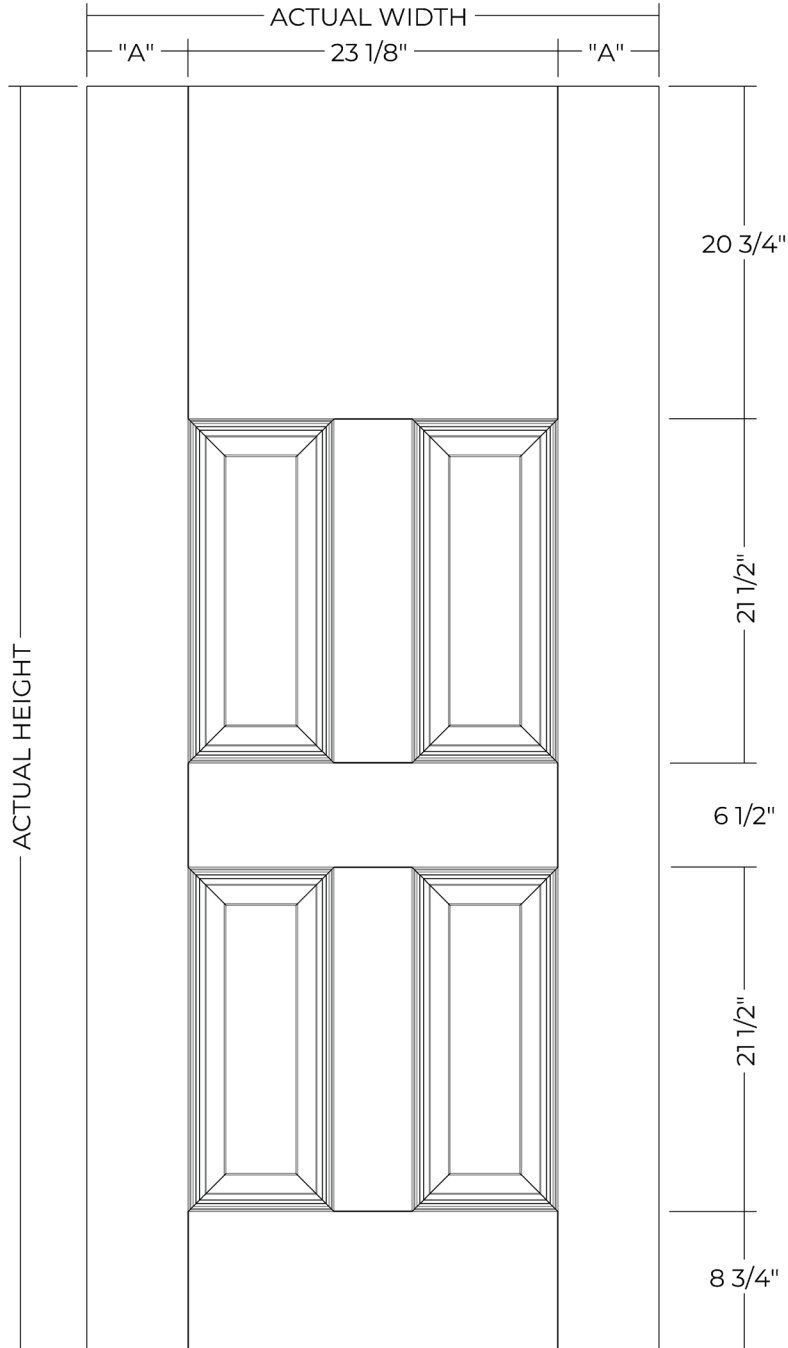

DOOR WIDTH		
NOMINAL	ACTUAL	"A"
2-8	31 3/4"	4 5/16"
2-10	33 3/4"	5 5/16"
3-0	35 3/4"	6 5/16"

DOOR HEIGHT	
NOMINAL	ACTUAL
6-8	79"

GLASS OPTIONS	
SIZE	CUTOUT
8 x 6	9 x 7
22 x 10	23 x 11
22 x 36	23 x 37
22 x 36 RT	23 x 37 RT
22 x 64	23 x 65

PRO OAK

6'8" 2 PANEL CAMBER PLANK

FIBERGLASS DOOR

TAN OAK | TAN

WHITE OAK | WHITE

PRO OAK

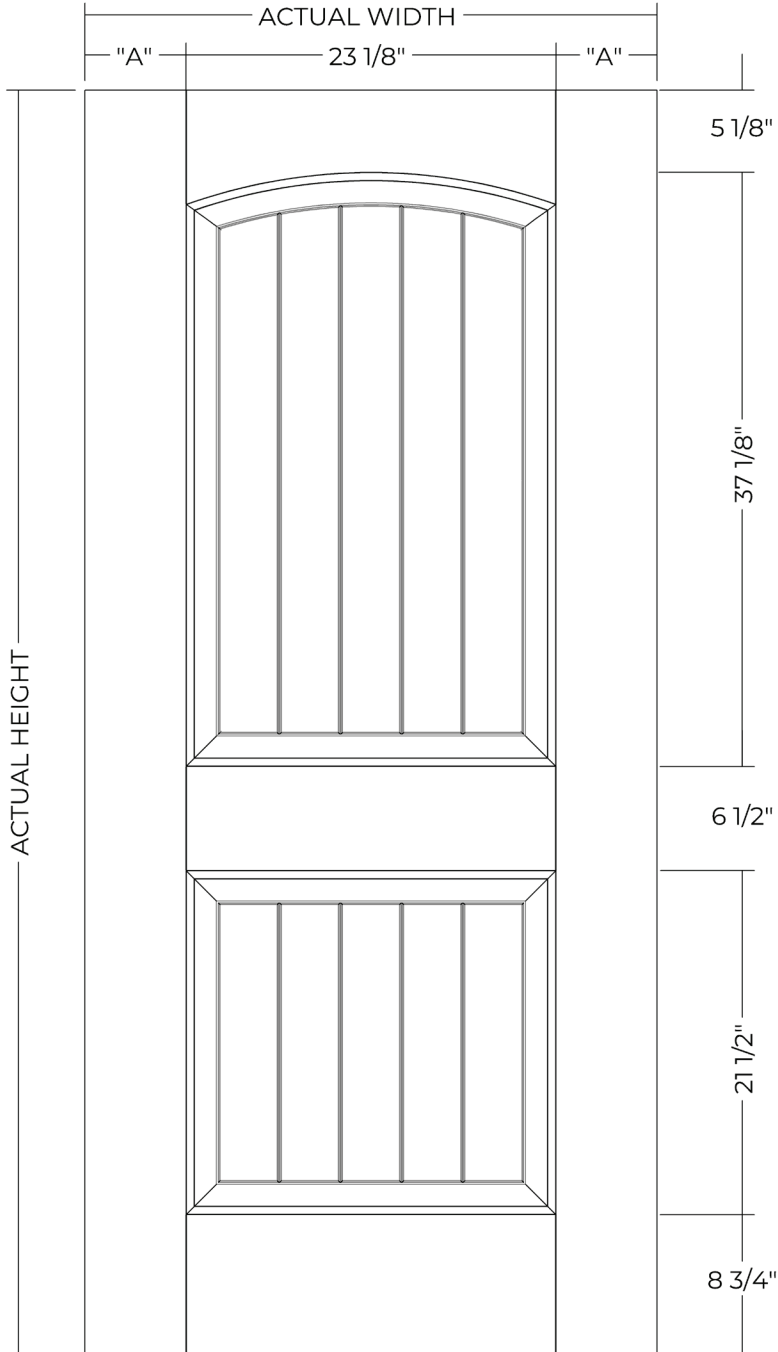

DOOR WIDTH		
NOMINAL	ACTUAL	"A"
2-8	31 3/4"	4 5/16"
2-10	33 3/4"	5 5/16"
3-0	35 3/4"	6 5/16"

DOOR HEIGHT	
NOMINAL	ACTUAL
6-8	79"

GLASS OPTIONS	
SIZE	CUTOUT
22 x 36	23 x 37
22 x 64	23 x 65

6'8" FLUSH

FIBERGLASS SIDELIGHT

TAN OAK | TAN | WHITE OAK | WHITE

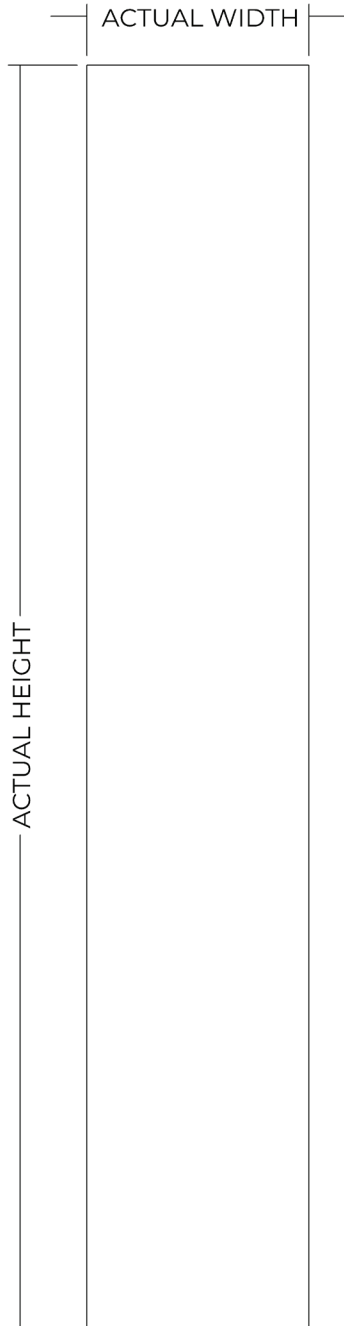

SIDELIGHT WIDTH	
NOMINAL	ACTUAL
1-0	11 7/8"
1-2	13 7/8"

SIDELIGHT HEIGHT	
NOMINAL	ACTUAL
6-8	79"

GLASS OPTIONS	
SIZE	CUTOUT
7 x 64	8 x 65
8 x 64	9 x 65

* Light frame required to verify cutout size

PRO OAK

CLASSIC FLUSH GLAZED

FIBERGLASS DOORS AND SIDELIGHTS



6'8" 1 LIGHT

FIBERGLASS DOOR

SATIN SMOOTH | WHITE

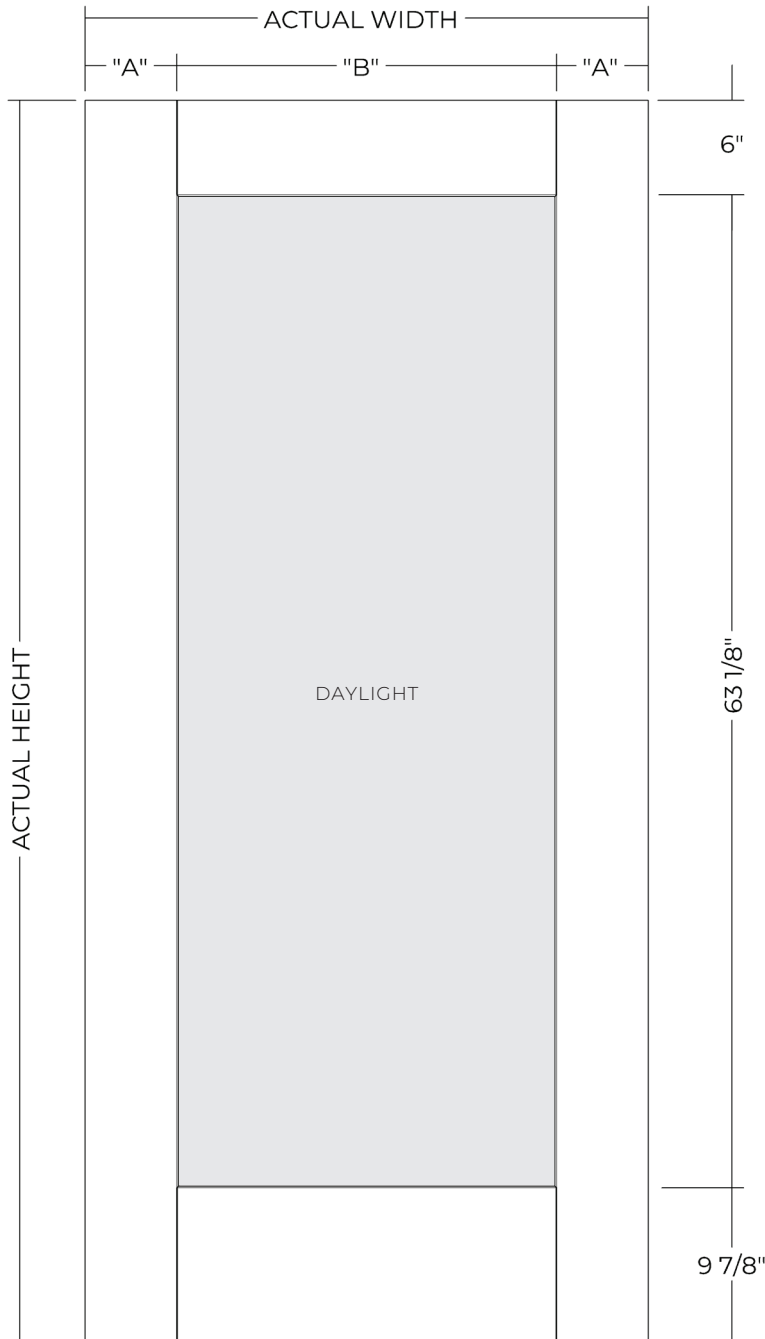

DOOR WIDTH - 20 X 64 GLASS SIZE

NOMINAL	ACTUAL	"A"	"B"
2-6	29 3/4"	4 5/16"	19 1/8"

DOOR HEIGHT

NOMINAL	ACTUAL
6-8	79"

GLASS OPTIONS

SIZE	DAYLIGHT
20 x 64	18 7/8 x 62 7/8

DOOR WIDTH - 22 X 64 GLASS SIZE

NOMINAL	ACTUAL	"A"	"B"
2-8	31 3/4"	5 7/16"	21 1/8"
2-10	33 3/4"	6 5/16"	21 1/8"
3-0	35 3/4"	7 5/16"	21 1/8"

DOOR HEIGHT

NOMINAL	ACTUAL
6-8	79"

GLASS OPTIONS

SIZE	DAYLIGHT
22 x 64	20 7/8 x 62 7/8

DOOR WIDTH - 25 X 64 GLASS SIZE

NOMINAL	ACTUAL	"A"	"B"
2-10	33 3/4"	4 13/16"	24 1/8"
3-0	35 3/4"	5 13/16"	24 1/8"

DOOR HEIGHT

NOMINAL	ACTUAL
6-8	79"

GLASS OPTIONS

SIZE	DAYLIGHT
25 x 64	23 7/8 x 62 7/8

FLUSH GLAZED

6'8" 1 LIGHT NARROW

FIBERGLASS DOOR

SATIN SMOOTH | WHITE

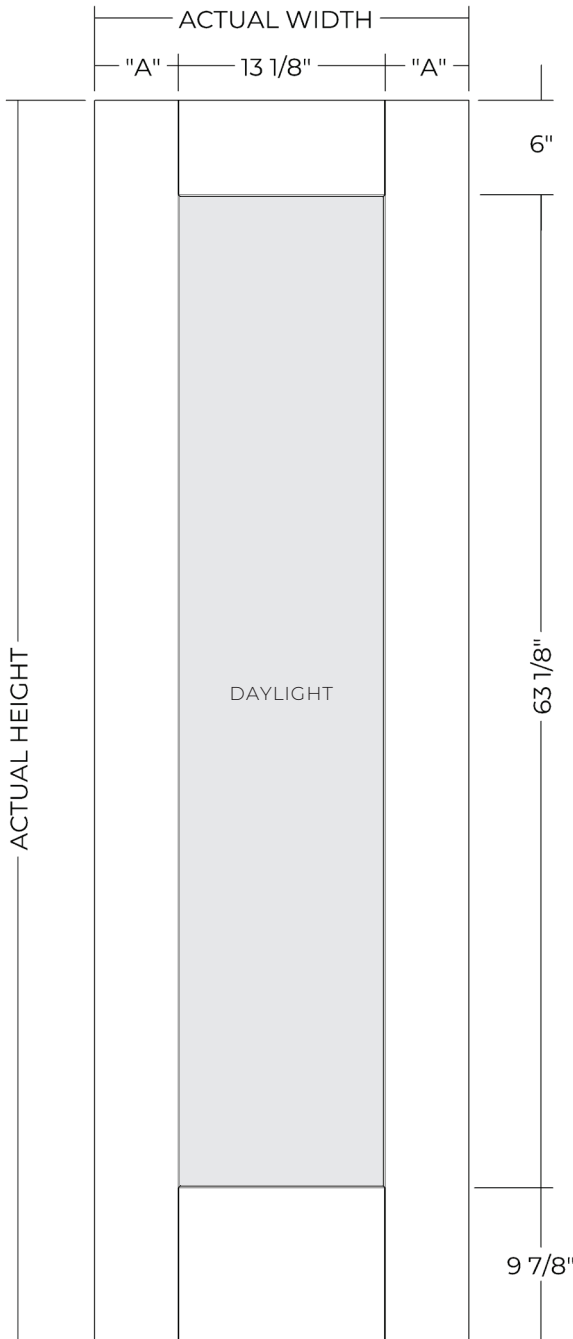

DOOR WIDTH		
NOMINAL	ACTUAL	"A"
2-0	23 3/4"	5 5/16"

DOOR HEIGHT	
NOMINAL	ACTUAL
6-8	79"

GLASS OPTIONS	
SIZE	DAYLIGHT
14 x 64	12 7/8 x 62 7/8



FLUSH GLAZED

6'8" 1 LIGHT

FIBERGLASS SIDELIGHT

SATIN SMOOTH | WHITE

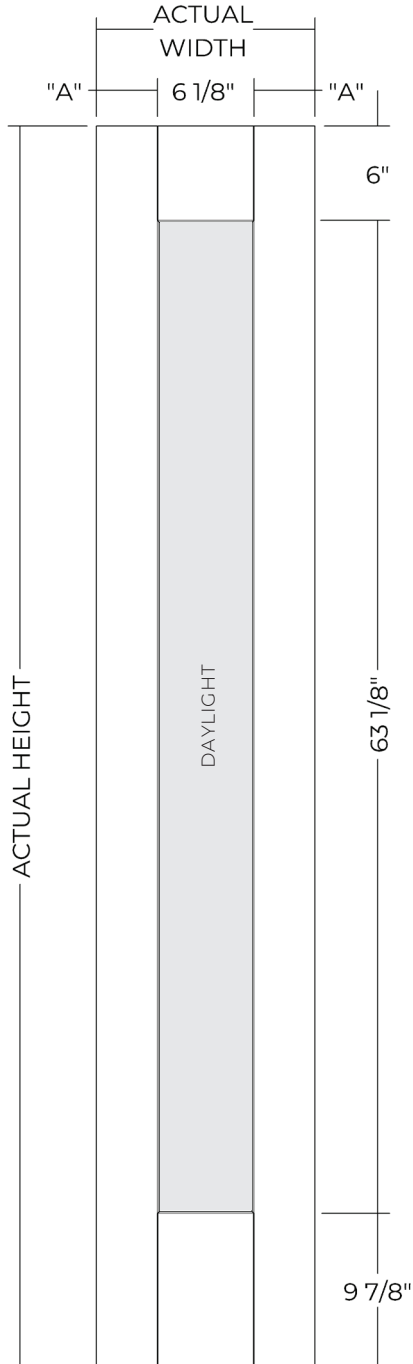

SIDELIGHT WIDTH		
NOMINAL	ACTUAL	"A"
1-0	11 7/8"	2 7/8"
1-2	13 7/8"	3 7/8"

SIDELIGHT HEIGHT	
NOMINAL	ACTUAL
6-8	79"

GLASS OPTIONS	
SIZE	DAYLIGHT
7 x 64	5 7/8 x 62 7/8

FLUSH GLAZED

8'0" 1 LIGHT

FIBERGLASS DOOR

SATIN SMOOTH | WHITE

FLUSH GLAZED

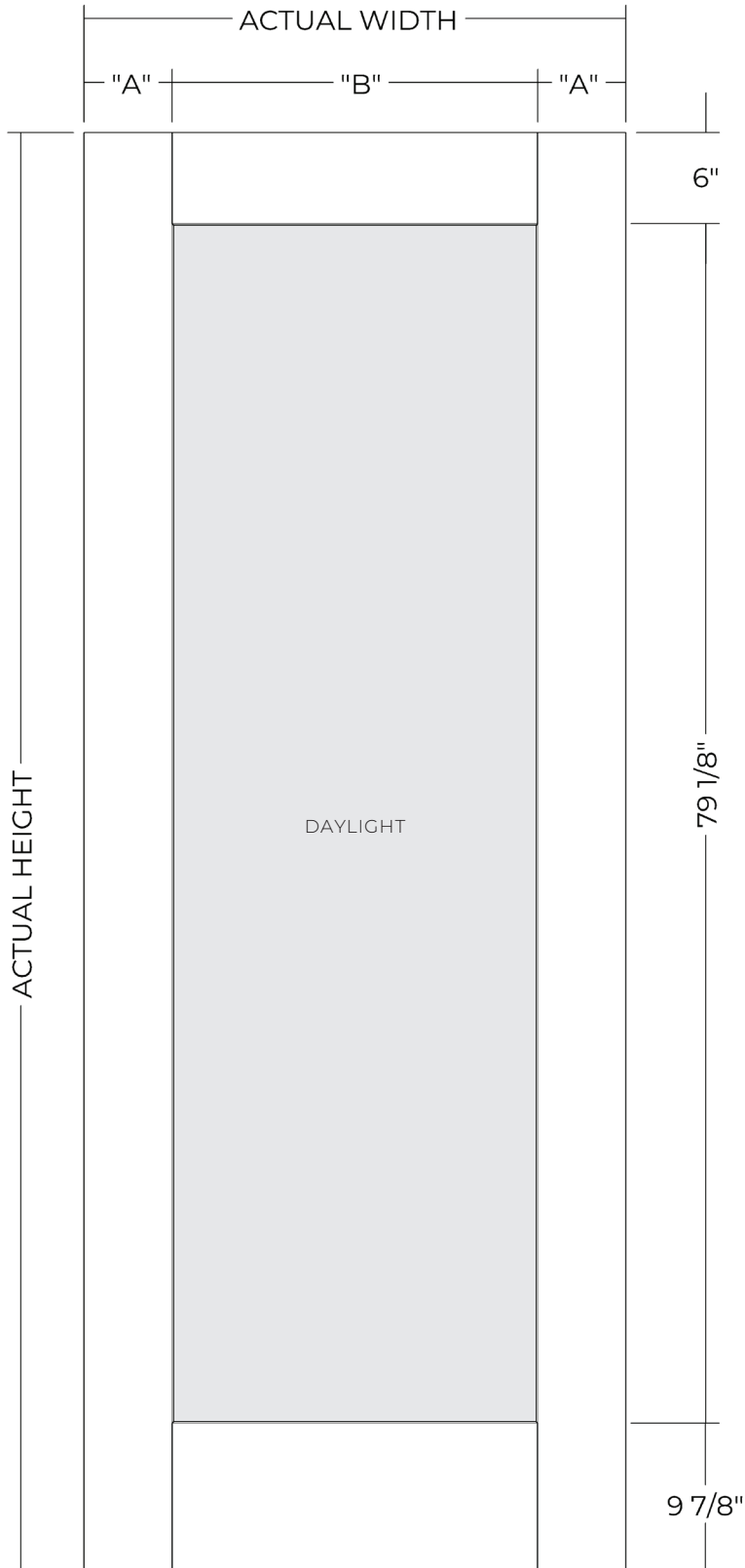

DOOR WIDTH - 20 X 64 GLASS SIZE

NOMINAL	ACTUAL	"A"	"B"
2-6	29 3/4"	4 5/16"	19 1/8"

DOOR HEIGHT

NOMINAL	ACTUAL
8-0	95"

GLASS OPTIONS

SIZE	DAYLIGHT
20 x 80	18 7/8 x 78 7/8

DOOR WIDTH - 22 X 64 GLASS SIZE

NOMINAL	ACTUAL	"A"	"B"
2-8	31 3/4"	5 7/16"	21 1/8"
2-10	33 3/4"	6 5/16"	21 1/8"
3-0	35 3/4"	7 5/16"	21 1/8"

DOOR HEIGHT

NOMINAL	ACTUAL
8-0	95"

GLASS OPTIONS

SIZE	DAYLIGHT
22 x 80	20 7/8 x 78 7/8

DOOR WIDTH - 25 X 64 GLASS SIZE

NOMINAL	ACTUAL	"A"	"B"
2-10	33 3/4"	4 13/16"	24 1/8"
3-0	35 3/4"	5 13/16"	24 1/8"

DOOR HEIGHT

NOMINAL	ACTUAL
8-0	95"

GLASS OPTIONS

SIZE	DAYLIGHT
25 x 80	23 7/8 x 78 7/8

8'0" 1 LIGHT NARROW

FIBERGLASS DOOR

SATIN SMOOTH | WHITE

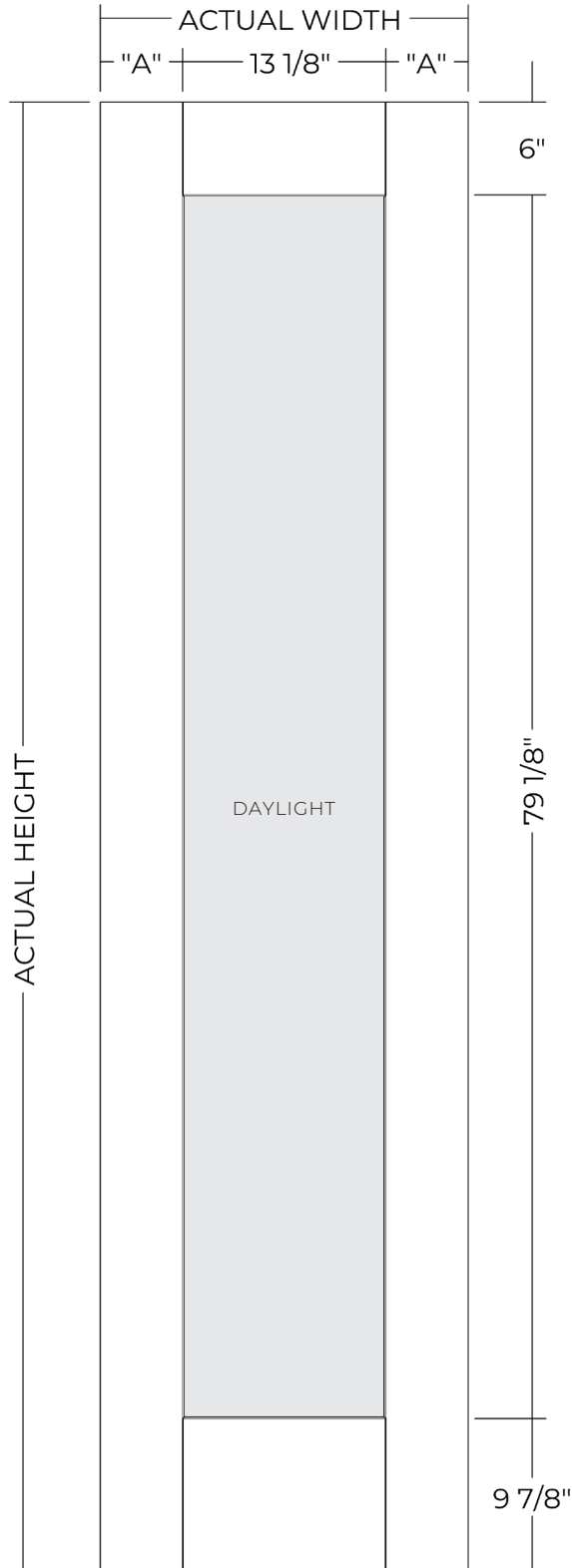

DOOR WIDTH

NOMINAL	ACTUAL	"A"
2-0	23 3/4"	5 5/16"

DOOR HEIGHT

NOMINAL	ACTUAL
8-0	95"

GLASS OPTIONS

SIZE	DAYLIGHT
14 x 80	12 7/8 x 78 7/8

FLUSH GLAZED

8'0" 1 LIGHT

FIBERGLASS SIDELIGHT

SATIN SMOOTH | WHITE

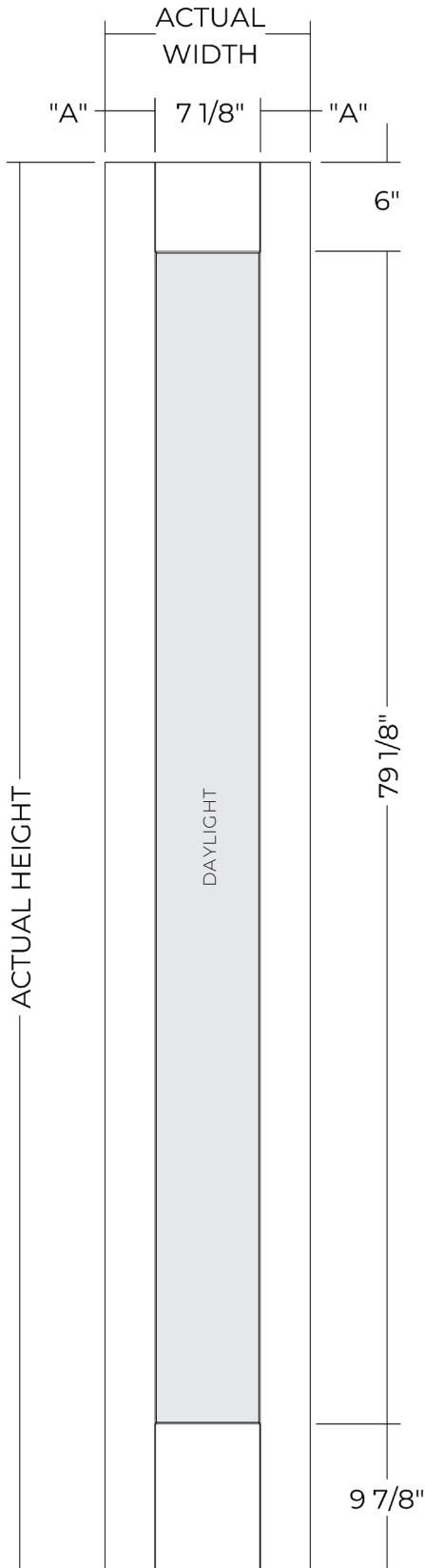

SIDELIGHT WIDTH		
NOMINAL	ACTUAL	"A"
1-0	11 7/8"	2 3/8"
1-2	13 7/8"	3 3/8"

SIDELIGHT HEIGHT	
NOMINAL	ACTUAL
8-0	95"

GLASS OPTIONS	
SIZE	DAYLIGHT
8 x 80	6 7/8 x 78 7/8

FLUSH GLAZED

ESTATE FLUSH GLAZED

FIBERGLASS DOORS AND SIDELIGHTS



6'8" 3/4 LIGHT ESTATE

FIBERGLASS DOOR

SATIN SMOOTH | WHITE

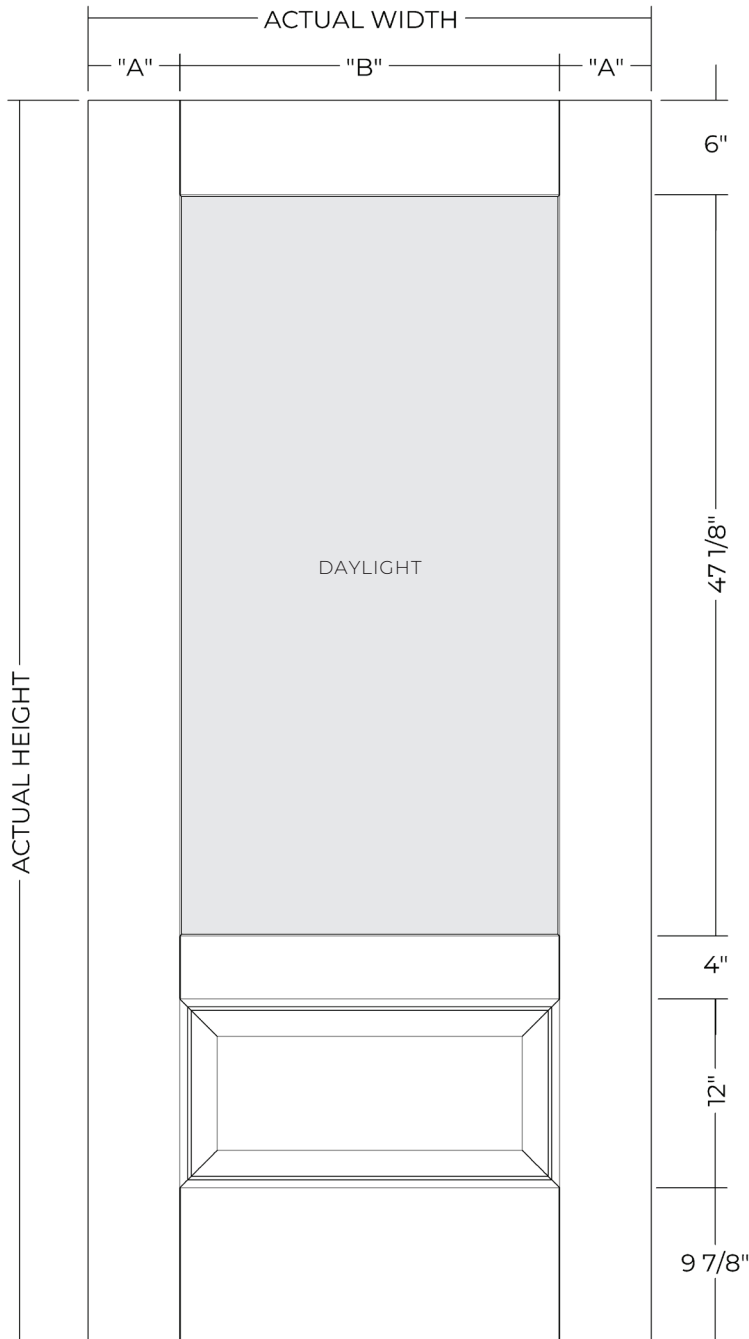

DOOR WIDTH - 20 X 48 GLASS SIZE

NOMINAL	ACTUAL	"A"	"B"
2-6	29 3/4"	5 5/16"	19 1/8"
2-8	31 3/4"	5 5/16"	19 1/8"

DOOR HEIGHT

NOMINAL	ACTUAL
6-8	79"

GLASS OPTIONS

SIZE	DAYLIGHT
20 x 48	18 7/8 x 46 7/8

DOOR WIDTH - 22 X 48 GLASS SIZE

NOMINAL	ACTUAL	"A"	"B"
2-6	29 3/4"	4 5/16"	21 1/8"
2-8	31 3/4"	5 7/16"	21 1/8"
2-10	33 3/4"	6 5/16"	21 1/8"
3-0	35 3/4"	7 5/16"	21 1/8"

DOOR HEIGHT

NOMINAL	ACTUAL
6-8	79"

GLASS OPTIONS

SIZE	DAYLIGHT
22 x 48	20 7/8 x 46 7/8

DOOR WIDTH - 25 X 48 GLASS SIZE

NOMINAL	ACTUAL	"A"	"B"
2-10	33 3/4"	4 13/16"	24 1/8"
3-0	35 3/4"	5 13/16"	24 1/8"

DOOR HEIGHT

NOMINAL	ACTUAL
6-8	79"

GLASS OPTIONS

SIZE	DAYLIGHT
25 x 48	23 7/8 x 46 7/8

FLUSH GLAZED

6'8" CRAFTSMAN PLANK

FIBERGLASS DOOR

SATIN SMOOTH | WHITE

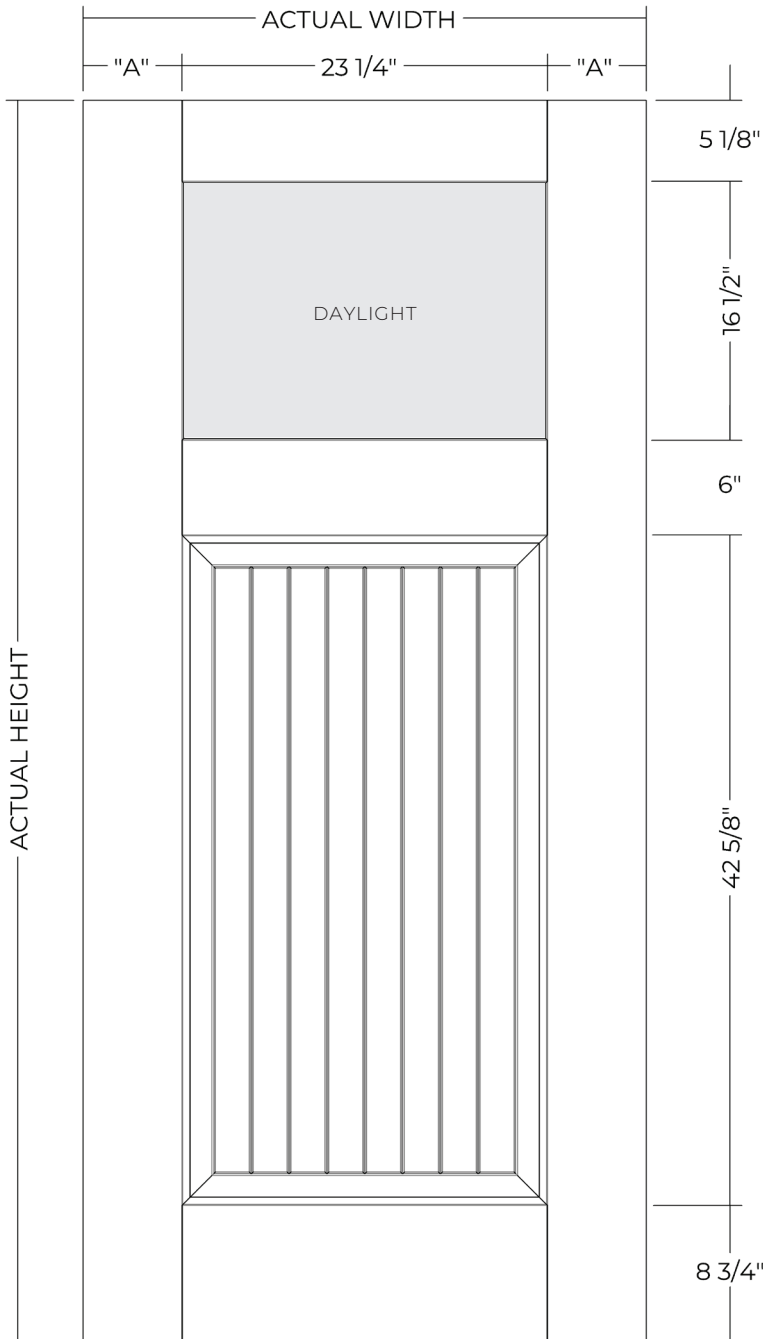

DOOR WIDTH		
NOMINAL	ACTUAL	"A"
2-8	31 3/4"	4 1/4"
2-10	33 3/4"	5 1/4"
3-0	35 3/4"	6 1/4"

DOOR HEIGHT	
NOMINAL	ACTUAL
6-8	79"

GLASS OPTIONS	
SIZE	DAYLIGHT
24 x 17 1/4"	22 7/8 x 16 1/8"



FLUSH GLAZED

6'8" 3/4 LIGHT ESTATE

FIBERGLASS SIDELIGHT

SATIN SMOOTH | WHITE

FLUSH GLAZED

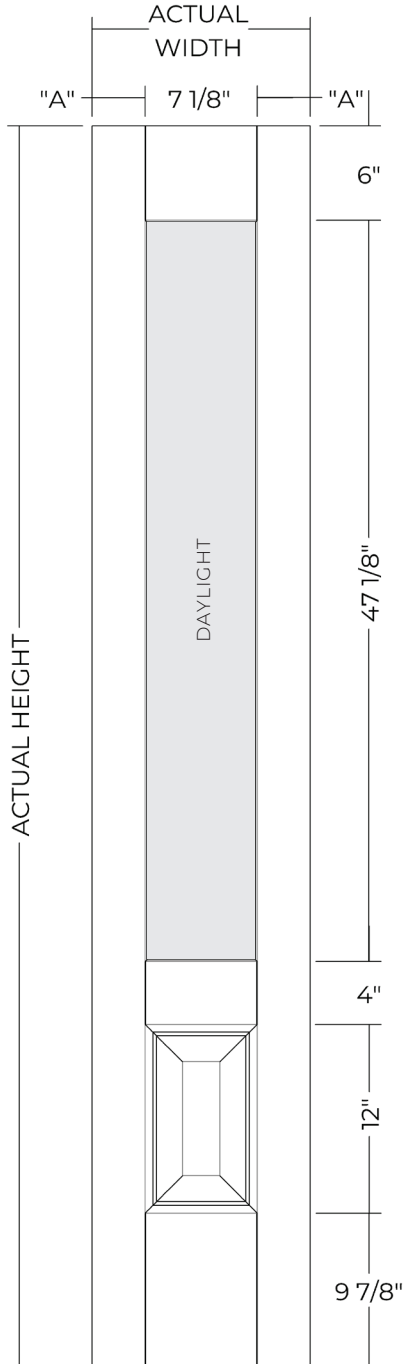

SIDELIGHT WIDTH		
NOMINAL	ACTUAL	"A"
1-0	11 7/8"	2 3/8"
1-2	13 7/8"	3 3/8"

SIDELIGHT HEIGHT	
NOMINAL	ACTUAL
6-8	79"

GLASS OPTIONS	
SIZE	DAYLIGHT
8 x 48	6 7/8 x 46 7/8

8'0" 3/4 LIGHT ESTATE

FIBERGLASS DOOR

SATIN SMOOTH | WHITE

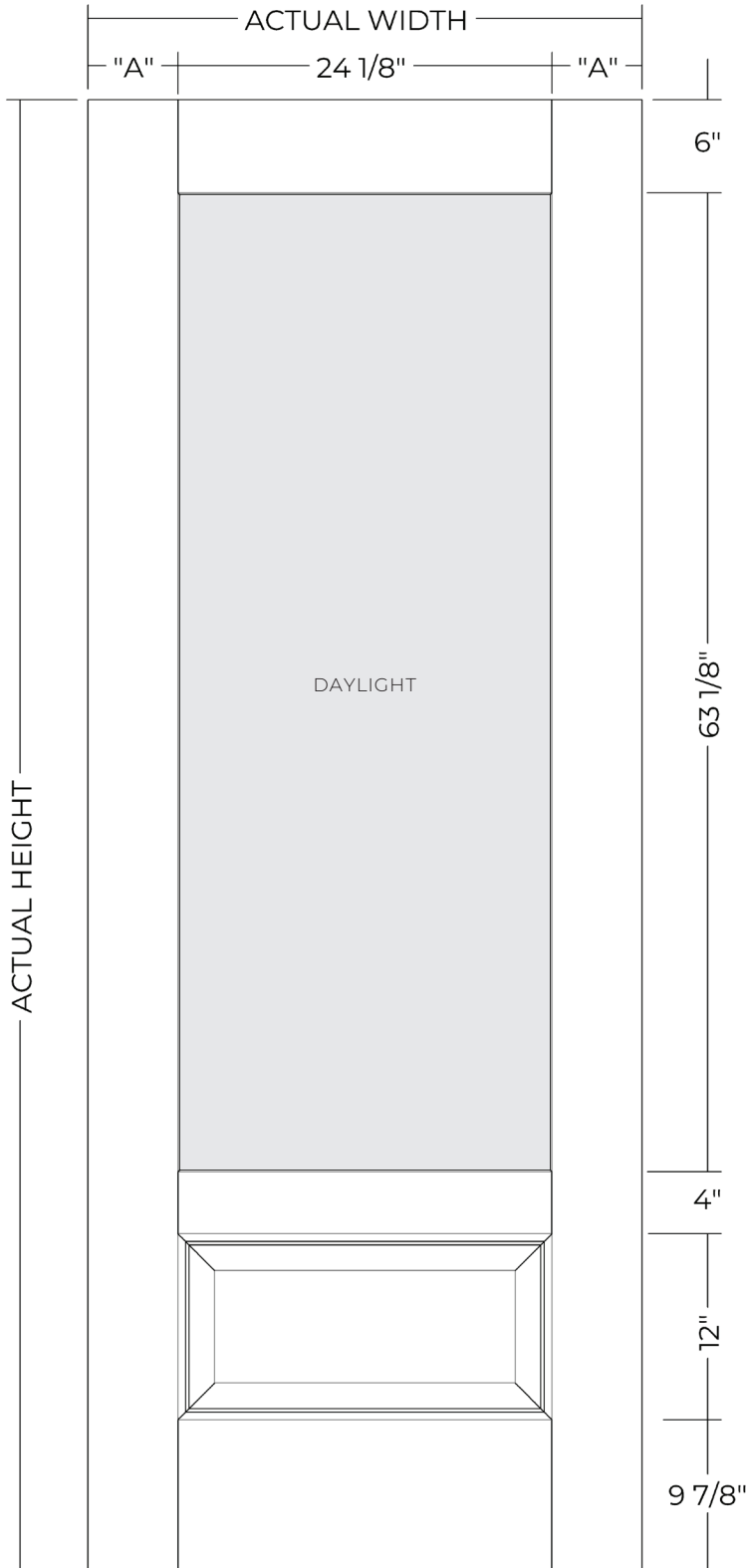

DOOR WIDTH - 20 X 64 GLASS SIZE

NOMINAL	ACTUAL	"A"	"B"
2-6	29 3/4"	5 5/16"	19 1/8"
2-8	31 3/4"	6 5/16"	19 1/8"

DOOR HEIGHT

NOMINAL	ACTUAL
8-0	95"

GLASS OPTIONS

SIZE	DAYLIGHT
20 x 64	18 7/8 x 62 7/8

DOOR WIDTH - 25 X 64 GLASS SIZE

NOMINAL	ACTUAL	"A"	"B"
2-10	33 3/4"	4 13/16"	24 1/8"
3-0	35 3/4"	5 13/16"	24 1/8"

DOOR HEIGHT

NOMINAL	ACTUAL
8-0	95"

GLASS OPTIONS

SIZE	DAYLIGHT
25 x 64	23 7/8 x 62 7/8

FLUSH GLAZED

8'0" 3/4 LIGHT ESTATE

FIBERGLASS SIDELIGHT

SATIN SMOOTH | WHITE

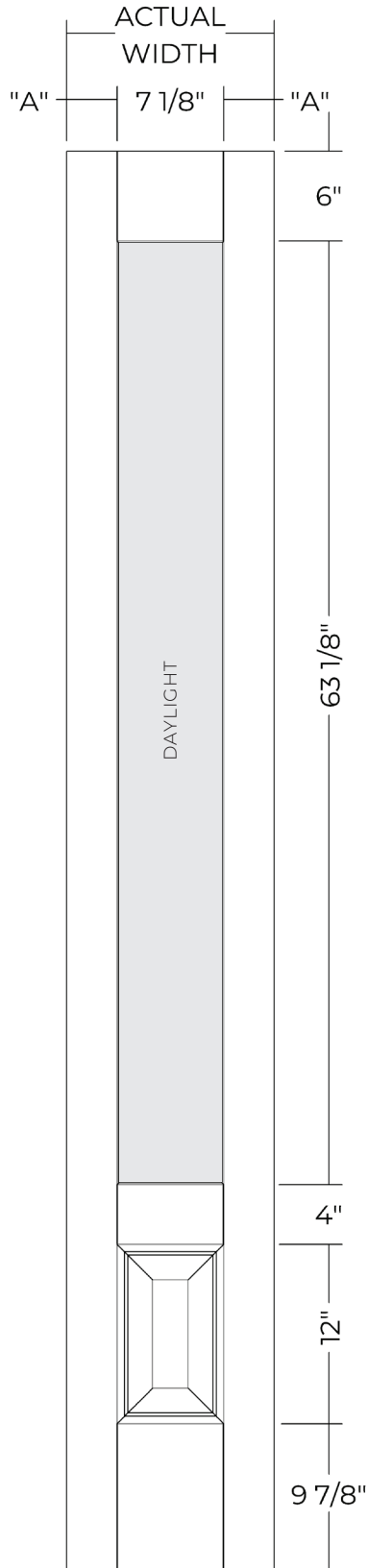

SIDELIGHT WIDTH		
NOMINAL	ACTUAL	"A"
1-0	11 7/8"	2 3/8"
1-2	13 7/8"	3 3/8"

SIDELIGHT HEIGHT	
NOMINAL	ACTUAL
8-0	95"

GLASS OPTIONS	
SIZE	DAYLIGHT
8 x 64	6 7/8 x 62 7/8

FLUSH GLAZED

SHAKER FLUSH GLAZED

FIBERGLASS DOORS AND SIDELIGHTS



6'8" 3/4 LIGHT SHAKER

FIBERGLASS DOOR

SATIN SMOOTH | WHITE

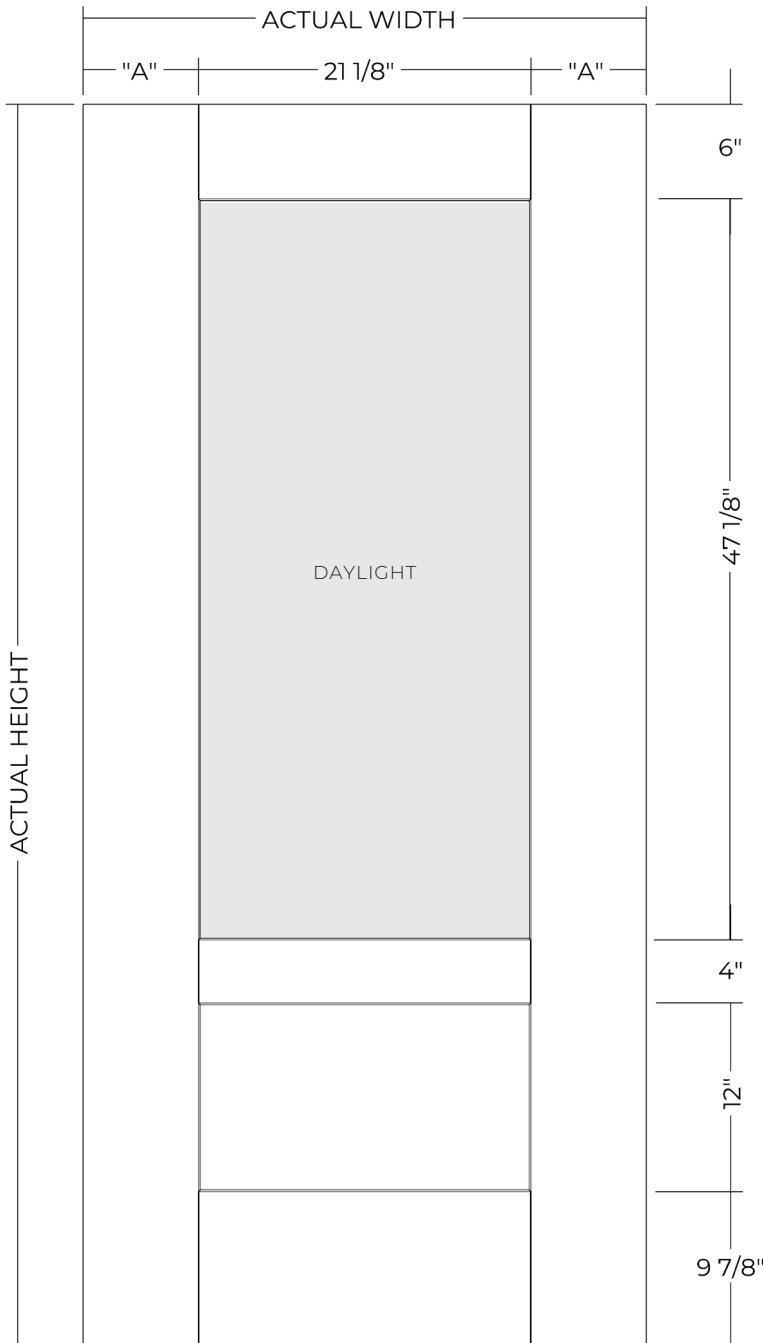

DOOR WIDTH		
NOMINAL	ACTUAL	"A"
2-8	31 3/4"	5 5/16"
2-10	33 3/4"	6 5/16"
3-0	35 3/4"	7 5/16"

DOOR HEIGHT	
NOMINAL	ACTUAL
6-8	79"

GLASS OPTIONS	
SIZE	DAYLIGHT
22 x 48	20 7/8 x 46 7/8



FLUSH GLAZED

6'8" 1/2 LIGHT SHAKER

FIBERGLASS DOOR

SATIN SMOOTH | WHITE

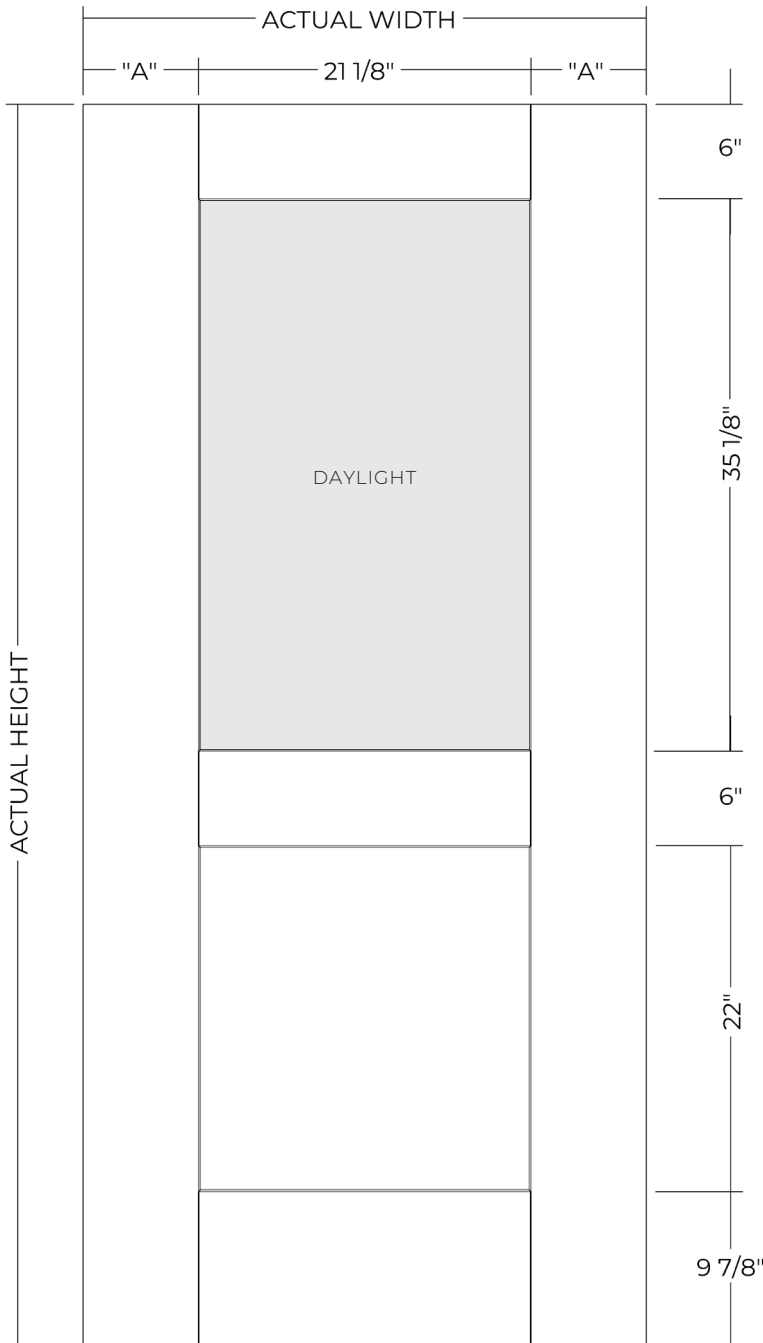

DOOR WIDTH		
NOMINAL	ACTUAL	"A"
2-8	31 3/4"	5 5/16"
2-10	33 3/4"	6 5/16"
3-0	35 3/4"	7 5/16"

DOOR HEIGHT	
NOMINAL	ACTUAL
6-8	79"

GLASS OPTIONS	
SIZE	DAYLIGHT
22 x 36	20 7/8 x 34 7/8

FLUSH GLAZED

6'8" 2 PANEL CRAFTSMAN

FIBERGLASS DOOR

RIFT CUT | TAN

SATIN SMOOTH | WHITE

DOOR WIDTH		
NOMINAL	ACTUAL	"A"
2-8	31 3/4"	4 1/4"
2-10	33 3/4"	5 1/4"
3-0	35 3/4"	6 1/4"

DOOR HEIGHT	
NOMINAL	ACTUAL
6-8	79"

GLASS OPTIONS	
SIZE	DAYLIGHT
24 x 17 1/4"	23 x 16 1/4"

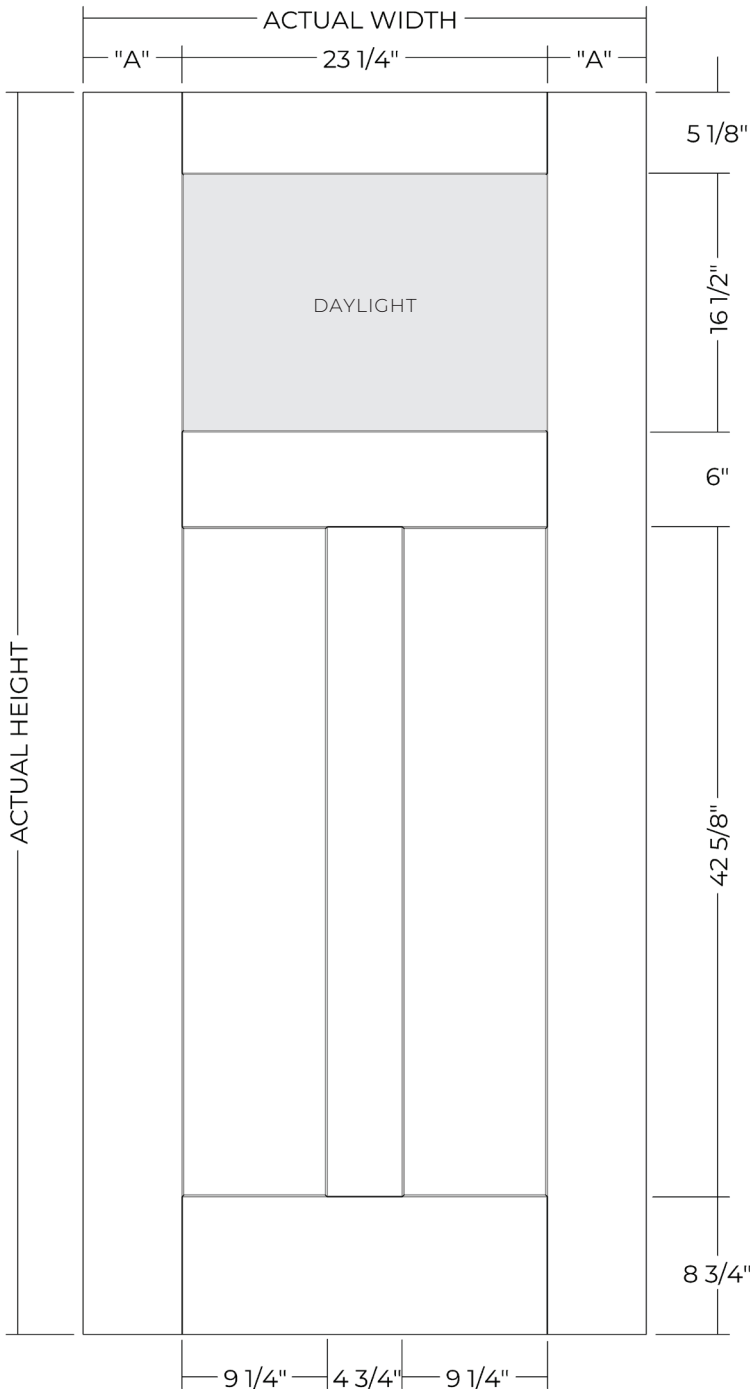

FLUSH GLAZED

6'8" 3/4 LIGHT SHAKER

FIBERGLASS SIDELIGHT

SATIN SMOOTH | WHITE

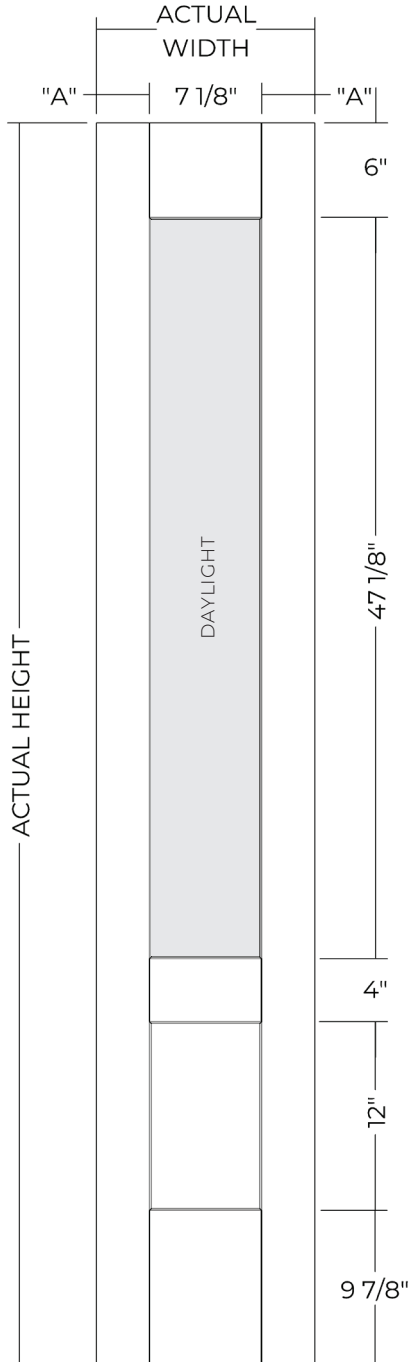

SIDELIGHT WIDTH		
NOMINAL	ACTUAL	"A"
1-0	11 7/8"	2 3/8"
1-2	13 3/4"	3 3/8"

SIDELIGHT HEIGHT	
NOMINAL	ACTUAL
6-8	79"

GLASS OPTIONS	
SIZE	DAYLIGHT
7 x 48	6 7/8 x 46 7/8

FLUSH GLAZED

6'8" CRAFTSMAN

FIBERGLASS SIDELIGHT

RIFT CUT | *TAN*

SATIN SMOOTH | *WHITE*

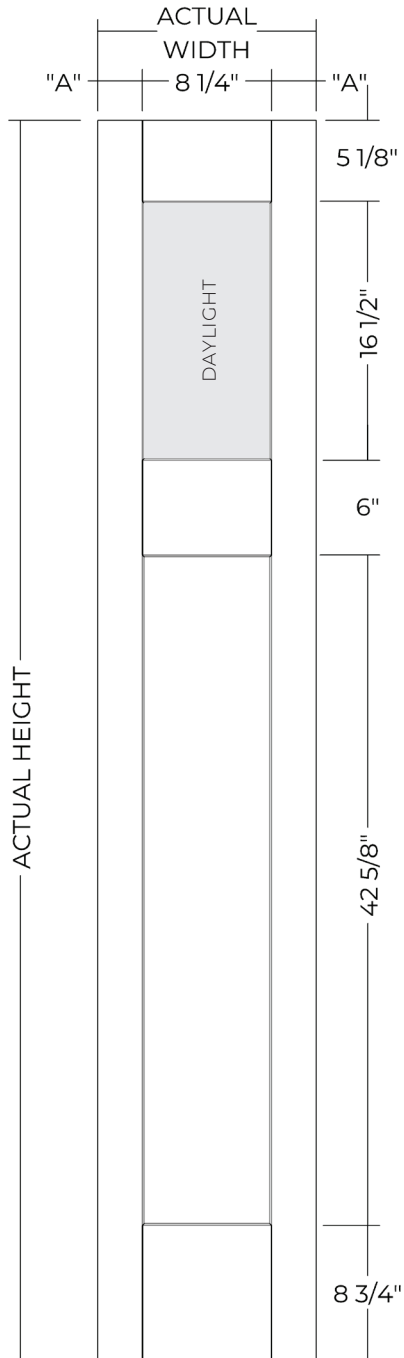

SIDELIGHT WIDTH		
NOMINAL	ACTUAL	"A"
1-0	11 7/8"	1 13/16"
1-2	13 7/8"	2 13/16"

SIDELIGHT HEIGHT	
NOMINAL	ACTUAL
6-8	79"

GLASS OPTIONS	
SIZE	DAYLIGHT
9 x 17 1/4	8 x 16 1/4

FLUSH GLAZED

8'0" 2 PANEL CRAFTSMAN

FIBERGLASS DOOR

RIFT CUT | TAN

SATIN SMOOTH | WHITE

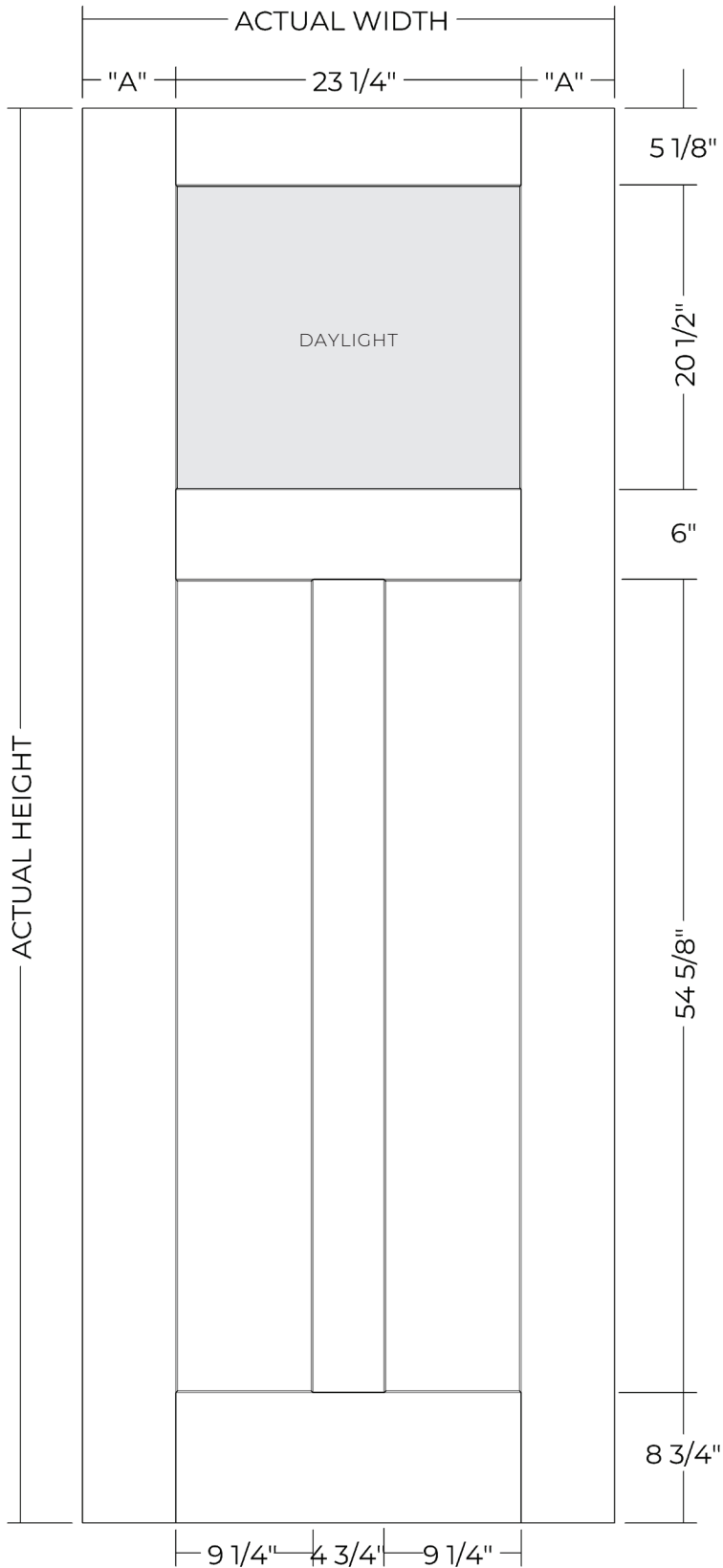

DOOR WIDTH		
NOMINAL	ACTUAL	"A"
2-8	31 3/4"	4 1/4"
2-10	33 3/4"	5 1/4"
3-0	35 3/4"	6 1/4"

DOOR HEIGHT	
NOMINAL	ACTUAL
8-0	95"

GLASS OPTIONS	
SIZE	DAYLIGHT
24 x 21 1/4"	22 7/8 x 20 1/8"

FLUSH GLAZED

8'0" CRAFTSMAN

FIBERGLASS SIDELIGHT

RIFT CUT | TAN

SATIN SMOOTH | WHITE

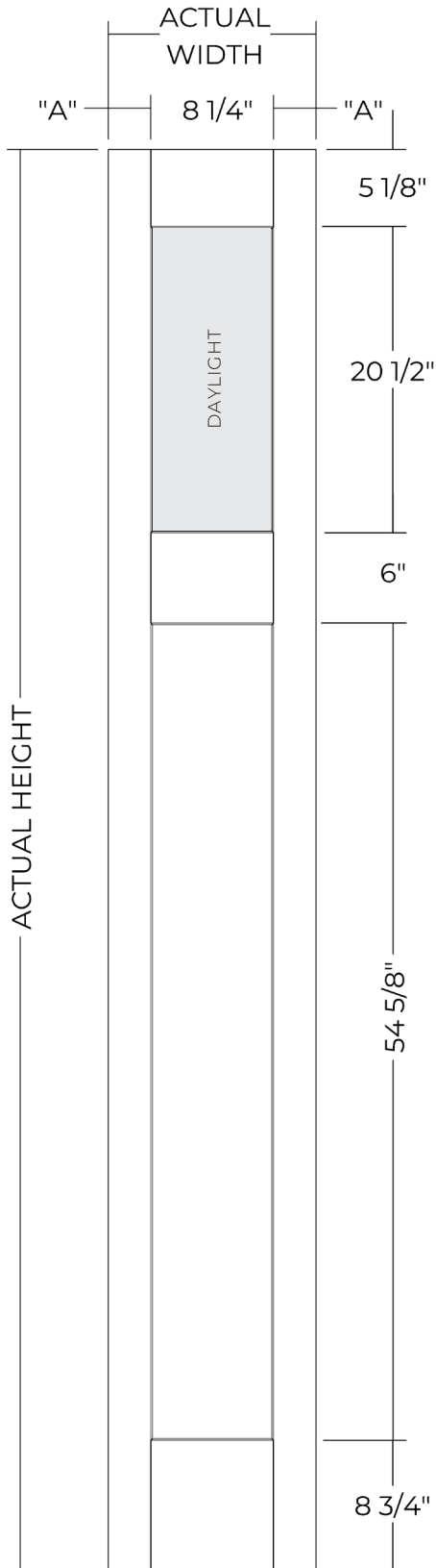

SIDELIGHT WIDTH		
NOMINAL	ACTUAL	"A"
1-0	11 7/8"	1 13/16"
1-2	13 7/8"	2 13/16"

SIDELIGHT HEIGHT	
NOMINAL	ACTUAL
8-0	95"

GLASS OPTIONS	
SIZE	DAYLIGHT
9 x 21 1/4	8 x 20 1/4

FLUSH GLAZED

STEEL DOORS



FEATURES

WOOD-EDGE STEEL DOORS

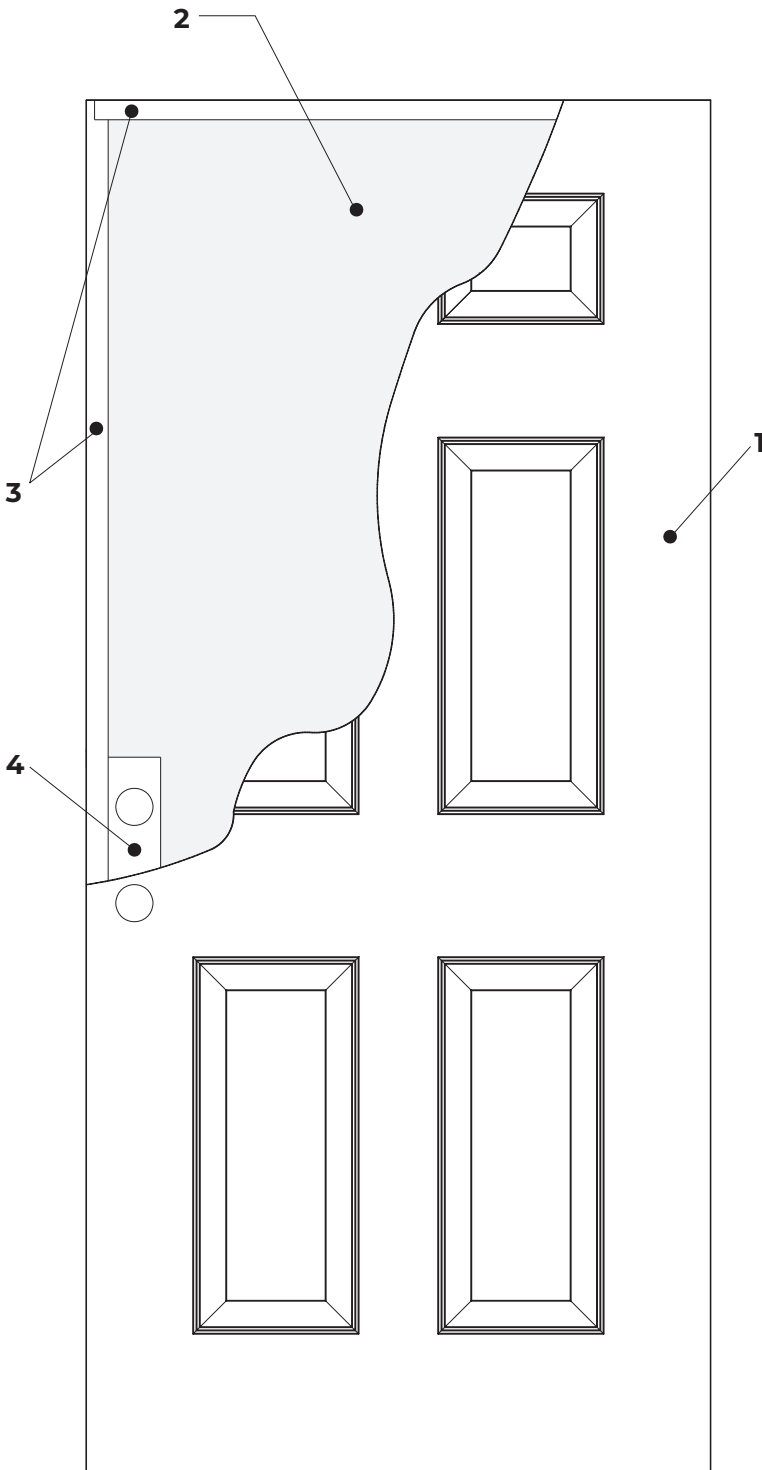

1.0 STEEL MARK, STEEL MARK PLUS & STEEL PRO SKINS

- 1.1 Grade:- G40 hot-dipped galvanized
- 1.2 24 gauge (Steel Mark & Steel Mark Plus)
- 1.3 25 gauge (Steel Pro)

2.0 FOAM CORE

- 2.1 Material: Polyurethane
- 2.2 Density: 2.2 lbs/cu.ft

3.0 WOOD PERIMETER

- 3.1 Material: spruce, pine, fir, or equivalent
- 3.2 Source: SFI 3rd party chain of custody certified

4.0 WOOD LOCK BLOCK

- 4.1 4" x 12" pine (includes stile thickness) 6'8" and 7'0"
- 4.2 4" x 24" pine (includes stile thickness) 8'0"

PRIMER | PAINT COATING

- Material – polyester based paint

PACKAGING

- Doors per pallet: 27
- SideLights per pallet: 30
- Banding: Metal (x2)
- Other: Corner boards (x4)
Polyfilm wrap
- Product identification all four sides
- Four way access pallet

FIRE RATING

- 20 minute positive pressure with hose stream up to 3'0" x 6'8"

STANDARD FEATURES

- 4" mortise hinge prep
- Cylindrical lock prep
- Proud edge design
- 1 3/4" door width

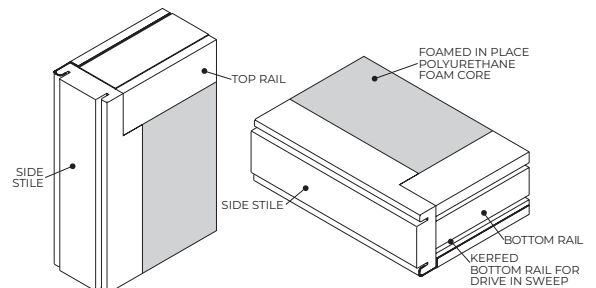

STILE & RAIL CONSTRUCTION DETAIL

FEATURES

STEEL-EDGE STEEL DOORS

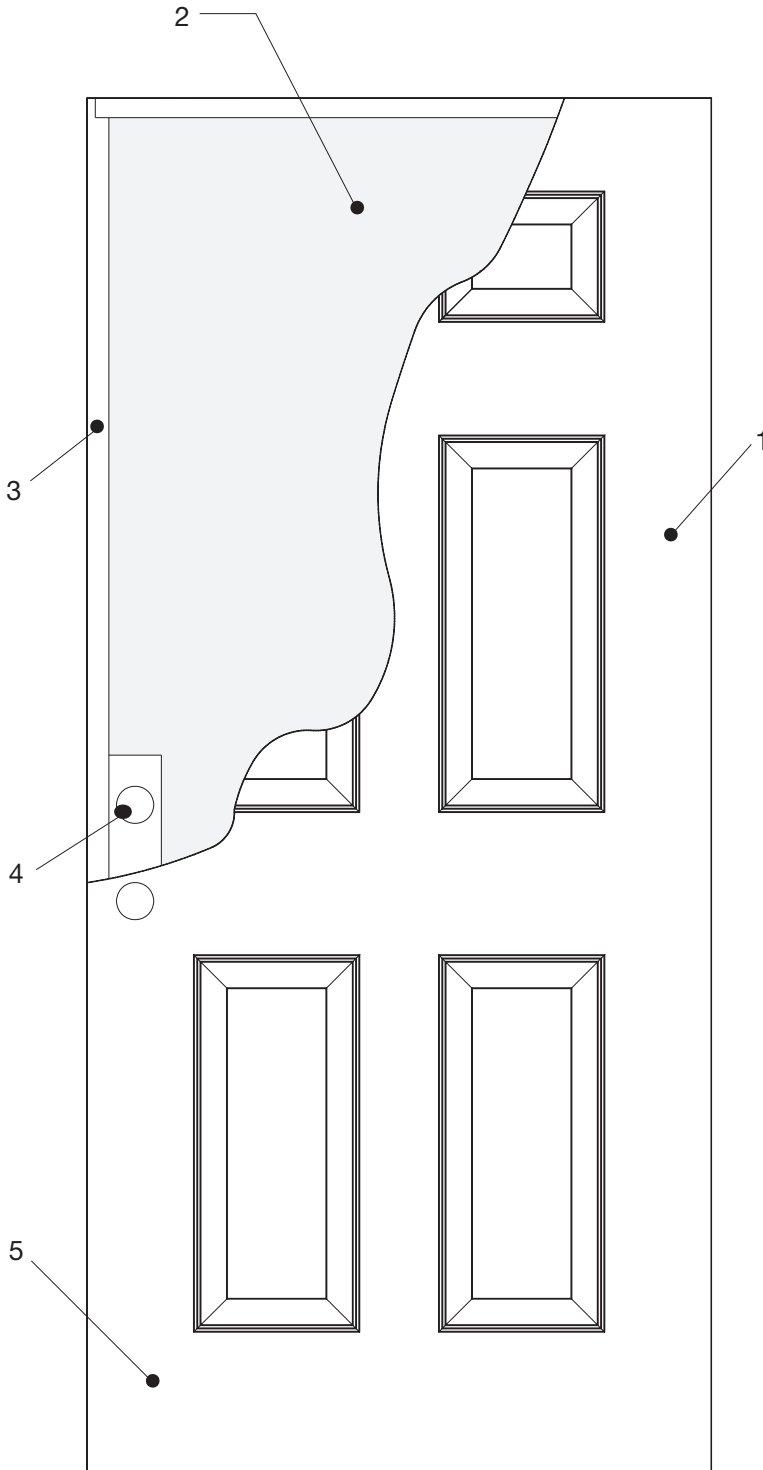

1.0 STEEL MARK & STEEL MARK PLUS SKINS

- 1.1 Grade:- G40 hot-dipped galvanized
- 1.2 24 gauge (Steel Mark & Steel Mark Plus)

2.0 FOAM CORE

- 2.1 Material: Polyurethane
- 2.2 Density: 2.2 lbs/cu.ft

3.0 WOOD PERIMETER WITH STEEL EDGE STILES

- 3.1 Material: spruce, pine, fir, or equivalent
- 3.2 Source: SFI 3rd party chain of custody certified
- 3.3 22 gauge steel edge plates

4.0 WOOD LOCK BLOCK

- 4.1 4" x 12" pine (includes stile thickness) 6'8"

PRIMER | PAINT COATING

- Material – polyester based paint

PACKAGING

- Doors per pallet: 27
- SideLights per pallet: 30
- Banding: Metal (x2)
- Other: Corner boards (x4) Polyfilm wrap
- Product identification all four sides
- Four way access pallet

FIRE RATING

- 20 minute positive pressure without hose stream up to 3'0" x 6'8"

STANDARD FEATURES

- 4" surface mounted adjustable hinge prep
- Cylindrical lock prep
- Proud edge design
- 13/4" door width

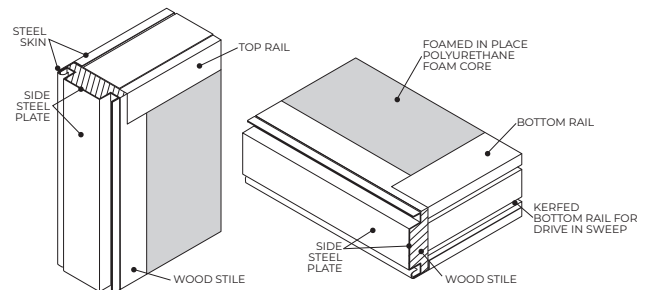

STILE & RAIL CONSTRUCTION DETAIL

EDGE PREP DETAILS

STEEL-EDGE STEEL DOORS

LATCH PREP

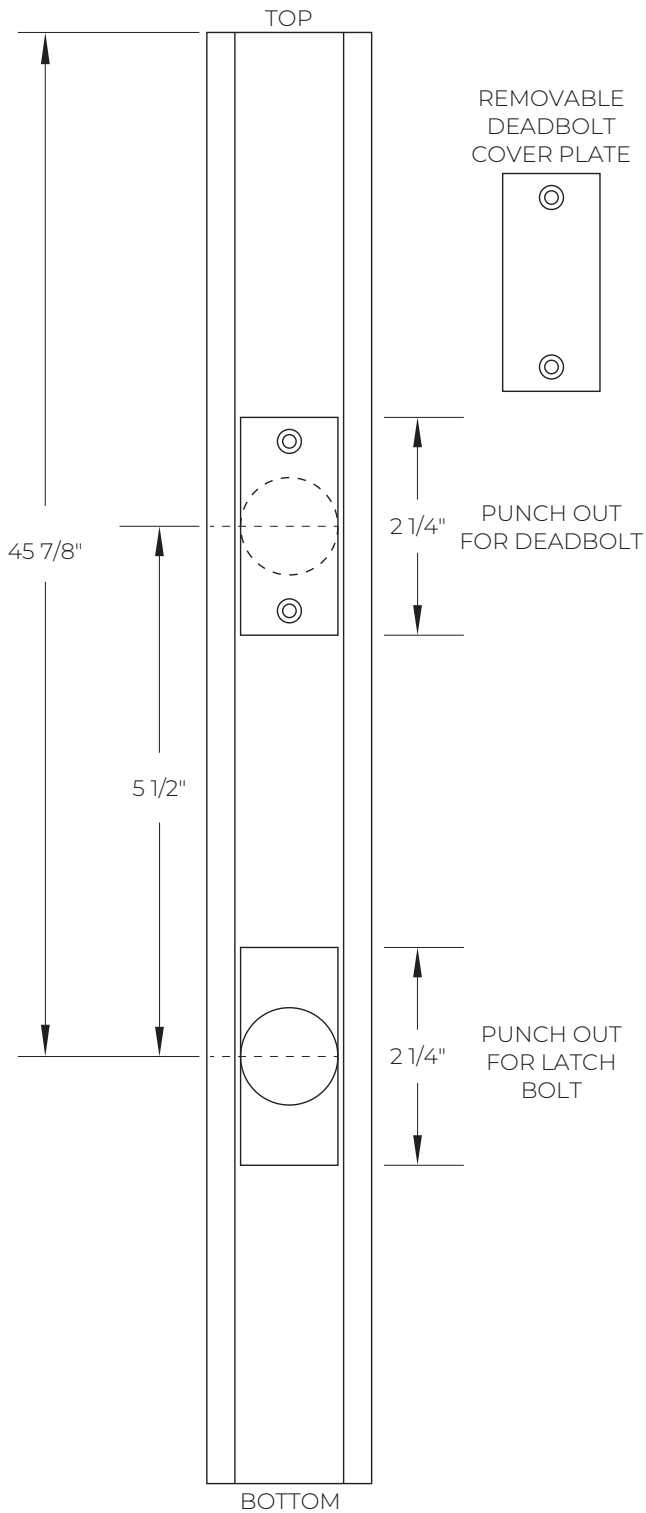

HINGE PREP

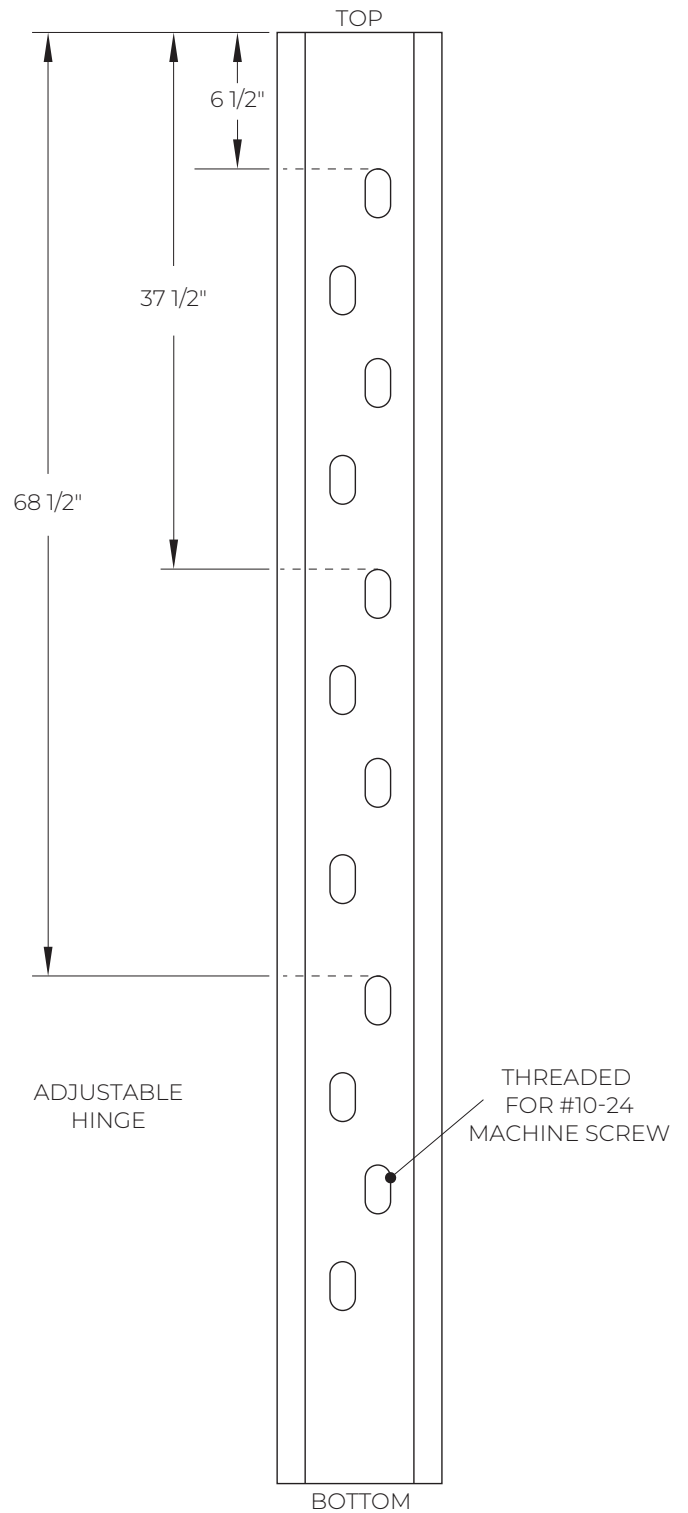

HARDWARE LOCATIONS

FOR WOOD-EDGE AND STEEL-EDGE STEEL DOORS

6'8" LOCATIONS WOOD-EDGE & STEEL EDGE 7'0" LOCATIONS WOOD-EDGE

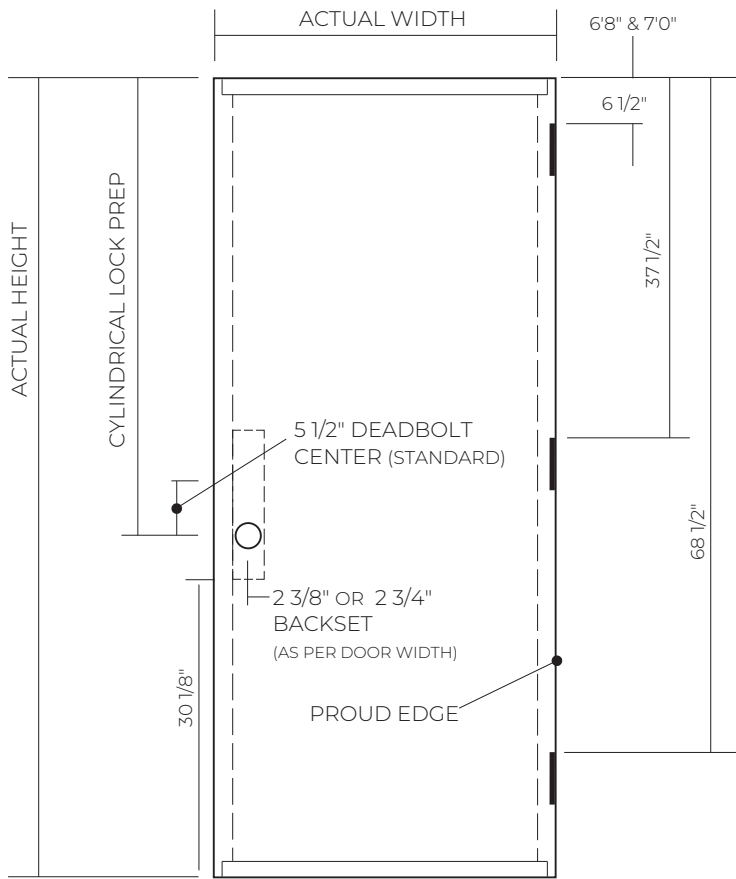

8'0" LOCATIONS WOOD-EDGE

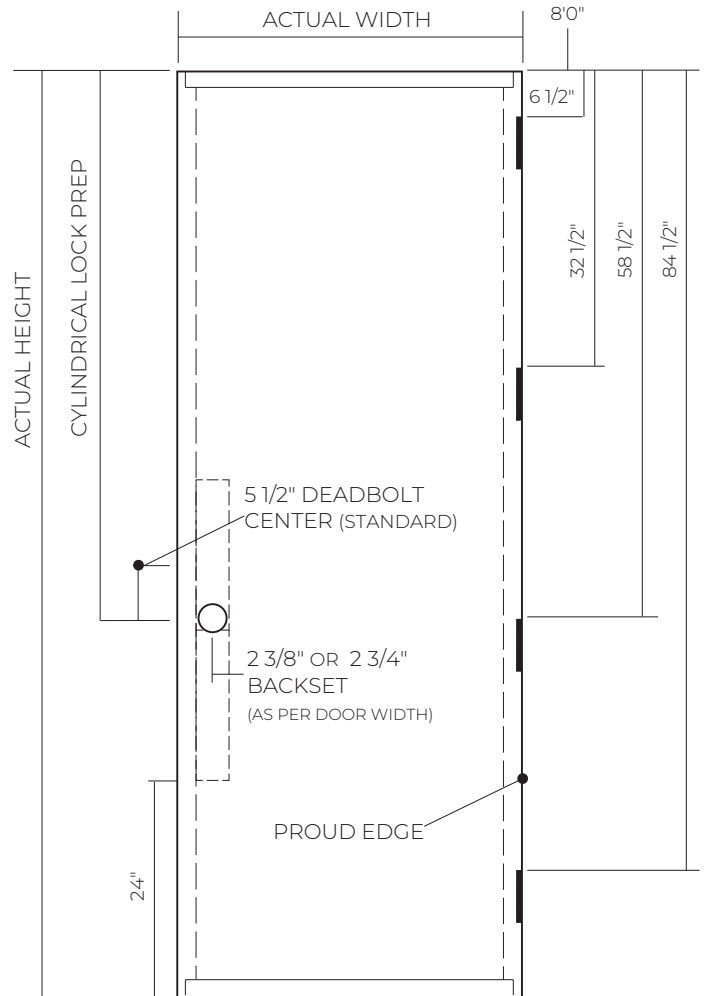

DOOR HEIGHT		
NOMINAL	ACTUAL	CYLINDRICAL PREP
6-8	79"	45 7/8"
7-0	83"	49 7/8"

DOOR HEIGHT		
NOMINAL	ACTUAL	CYLINDRICAL PREP
8-0	95"	59"

EMBOSSMENT PROFILES

STEEL DOORS AND SIDELIGHTS



HD EMBOSMENT

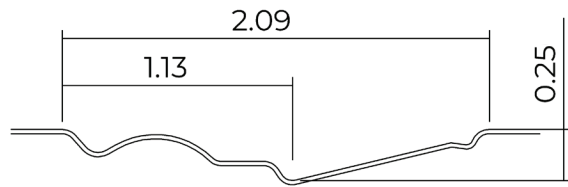

DETAILS EMBOSMENT

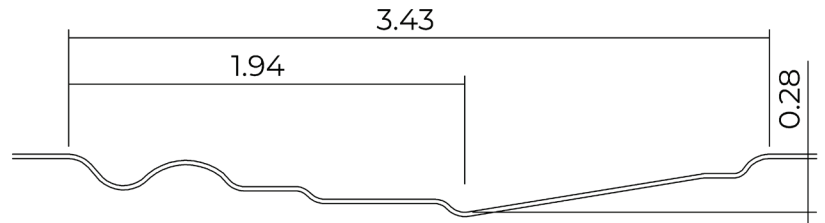

EUROLINE EMBOSMENT

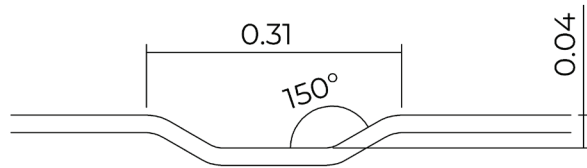

STANDARD EMBOSMENT

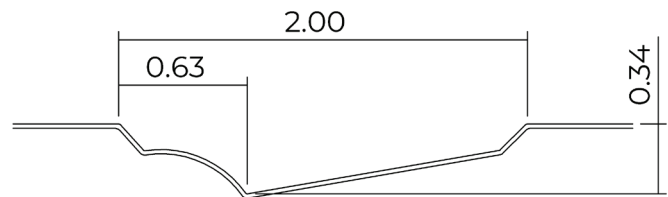

URBAN EMBOSMENT

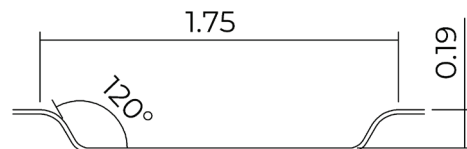

STEEL MARK® & STEEL MARK® PLUS

WOOD-EDGE AND STEEL EDGE DOORS AND SIDELIGHTS



6'8" FLUSH

STEEL DOOR

WOOD EDGE | *STEEL PRO*[®], *STEEL MARK*[®] & *STEEL MARK*[®] PLUS
 STEEL EDGE | *STEEL MARK*[®] & *STEEL MARK*[®] PLUS

STEEL MARK[®] & STEEL MARK[®] PLUS

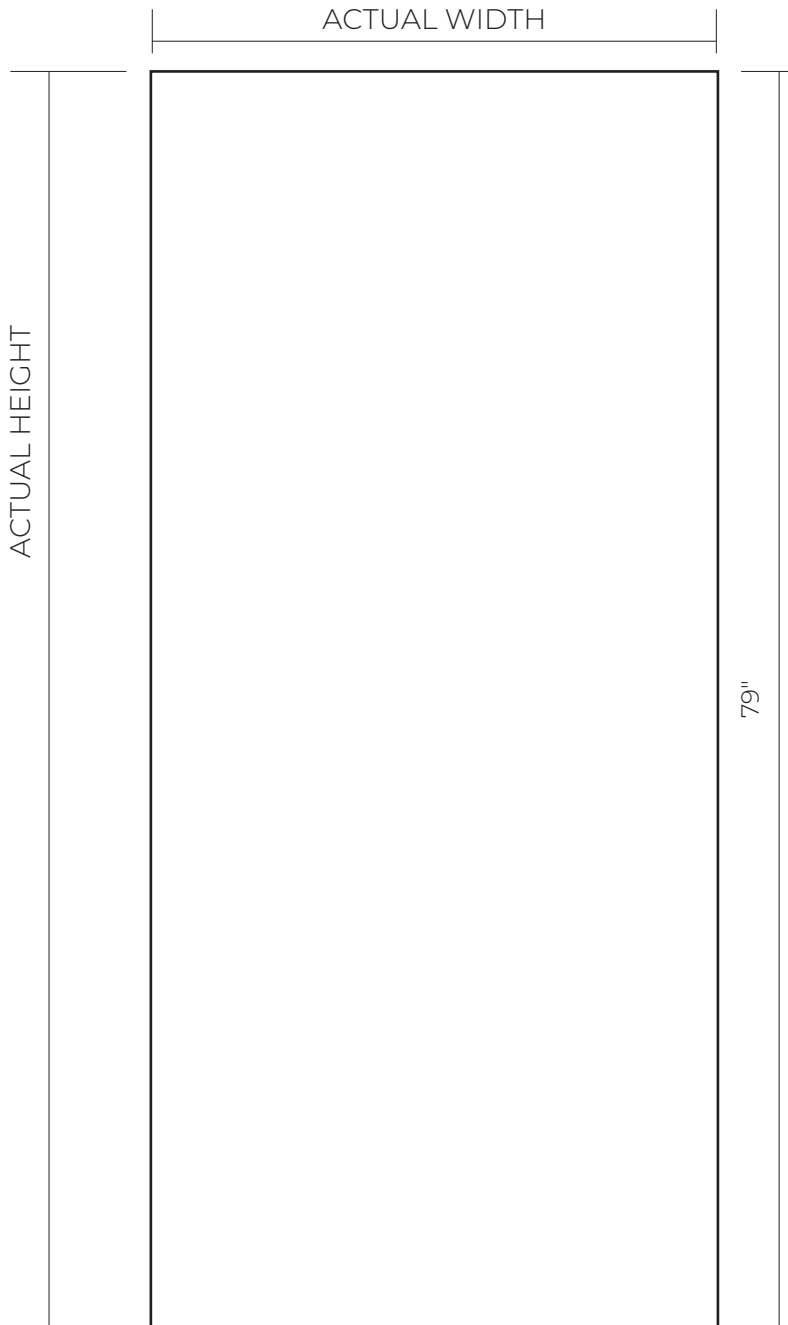

DOOR WIDTH - WOOD EDGE

NOMINAL	ACTUAL
2-6	29 3/4"
2-8	31 3/4"
2-10	33 3/4"
3-0	35 3/4"
3-6	41 3/4"

DOOR WIDTH - STEEL EDGE

NOMINAL	ACTUAL
2-6	29 11/16"
2-8	31 11/16"
2-10	33 11/16"
3-0	35 11/16"
3-6	41 11/16"

DOOR HEIGHT

NOMINAL	ACTUAL	CYLINDRICAL PREP
6-8	79"	45 7/8"

GLASS OPTIONS

SIZE	CUTOUT
8 x 6	9 x 7
8 x 36	9 x 37
7 x 64	8 x 65
8 x 64	9 x 65
22 x 10	23 x 11
22 x 36	23 x 37
22 x 48	23 x 49
22 x 64	23 x 65
22 x 17	23 x 18

GARDEN DOOR SIZES AVAILABLE

6'8" 6 PANEL

STEEL DOOR

WOOD EDGE | **STEEL PRO®**, **STEEL MARK®** & **STEEL MARK® PLUS**
 STEEL EDGE | **STEEL MARK®** & **STEEL MARK® PLUS**

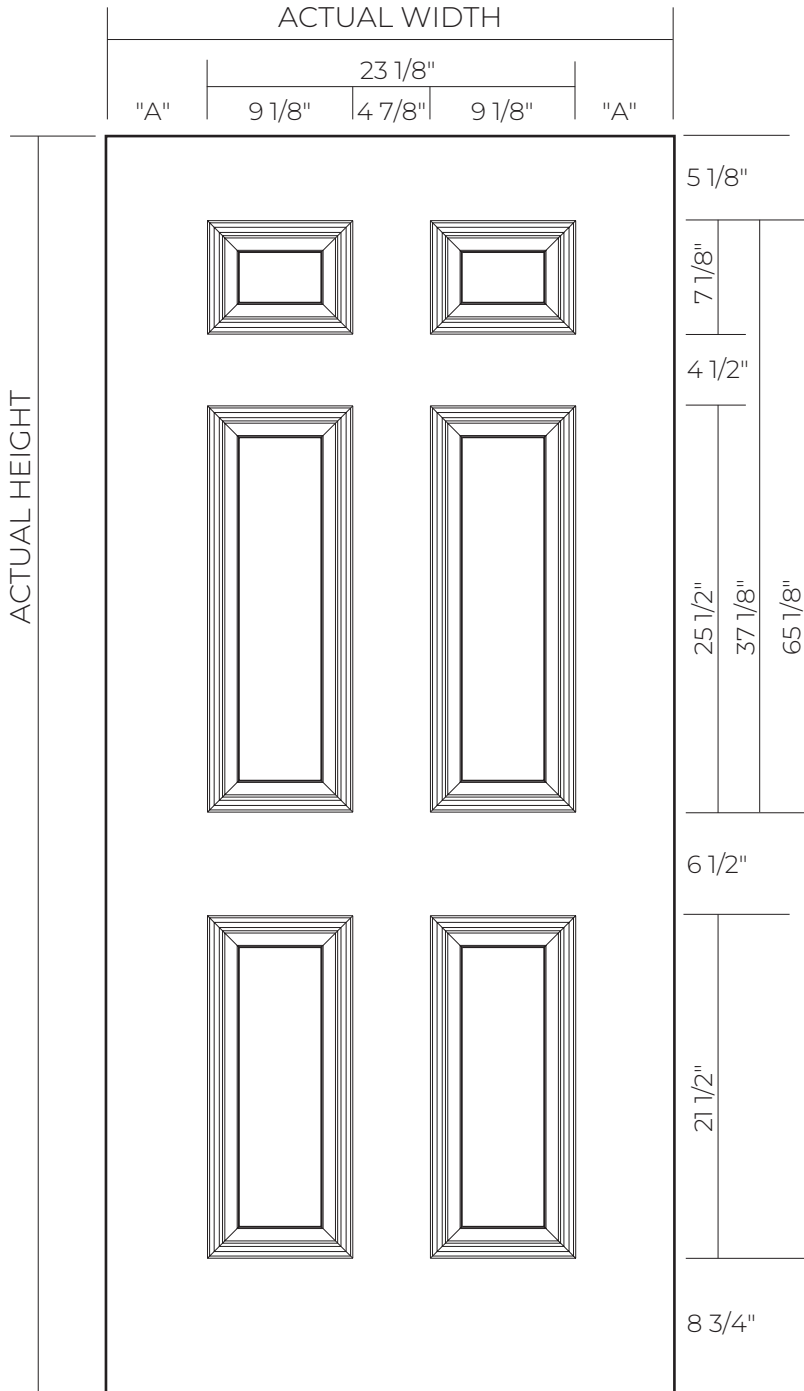

DOOR WIDTH - WOOD EDGE		
NOMINAL	ACTUAL	"A"
2-8	31 3/4"	4 5/16"
2-10	33 3/4"	5 5/16"
3-0	35 3/4"	6 5/16"

DOOR WIDTH - STEEL EDGE		
NOMINAL	ACTUAL	"A"
2-8	31 11/16"	4 9/32"
2-10	33 11/16"	5 9/32"
3-0	35 11/16"	6 9/32"

DOOR HEIGHT		
NOMINAL	ACTUAL	CYLINDRICAL PREP
6-8	79"	45 7/8"
7-0*	83"	49 7/8"

GLASS OPTIONS	
SIZE	CUTOUT
8 x 6	9 x 7
8 x 36	9 x 37
22 x 10	23 x 11
22 x 36	23 x 37
22 x 64	23 x 65

STEEL MARK® & STEEL MARK® PLUS

6'8" 4 PANEL

STEEL DOOR

WOOD EDGE | **STEEL PRO®**, **STEEL MARK®** & **STEEL MARK® PLUS**
 STEEL EDGE | **STEEL MARK®** & **STEEL MARK® PLUS**

STEEL MARK® & STEEL MARK® PLUS

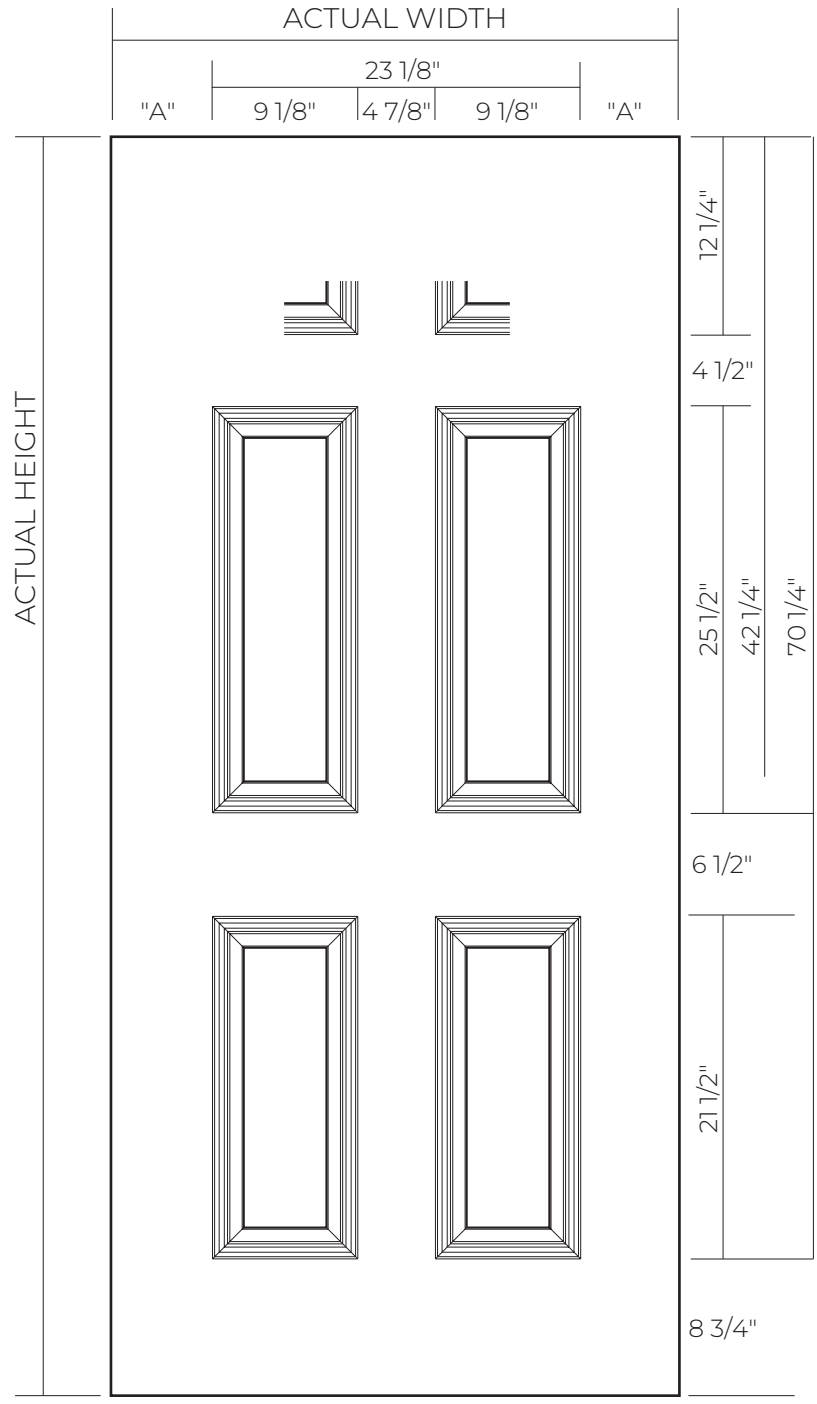

DOOR WIDTH - WOOD EDGE		
NOMINAL	ACTUAL	"A"
2-8	31 3/4"	4 5/16"
2-10	33 3/4"	5 5/16"
3-0	35 3/4"	6 5/16"

DOOR WIDTH - STEEL EDGE		
NOMINAL	ACTUAL	"A"
2-8	31 11/16"	4 9/32"
2-10	33 11/16"	5 9/32"
3-0	35 11/16"	6 9/32"

DOOR HEIGHT		
NOMINAL	ACTUAL	CYLINDRICAL PREP
6-8	79"	45 7/8"

GLASS OPTIONS	
SIZE	CUTOUT
8 x 6	9 x 7
8 x 36	9 x 37
8 x 36 RT*	9 x 37 RT
22 x 10 HR*	23 x 11 HR
22 x 36	23 x 37
22 x 36 RT*	23 x 37 RT
22 x 64	23 x 65

* Light frame required to verify cutout size

6'8" 3 PANEL

STEEL DOOR

WOOD EDGE | **STEEL MARK® & STEEL MARK® PLUS**
 STEEL EDGE | **STEEL MARK® & STEEL MARK® PLUS**

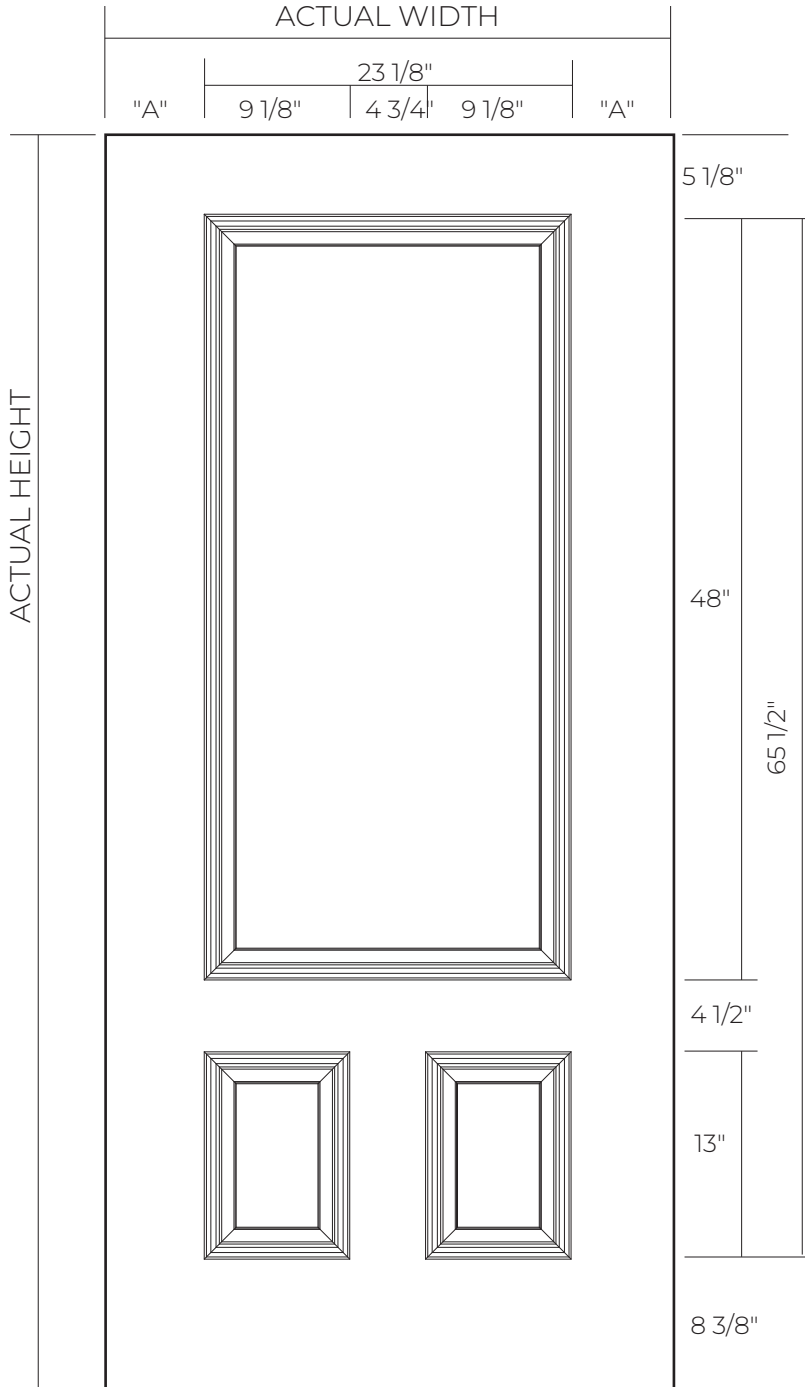

DOOR WIDTH - WOOD EDGE		
NOMINAL	ACTUAL	"A"
2-8	31 3/4"	4 5/16"
2-10	33 3/4"	5 5/16"
3-0	35 3/4"	6 5/16"

DOOR WIDTH - STEEL EDGE		
NOMINAL	ACTUAL	"A"
2-8	31 11/16"	4 9/32"
2-10	33 11/16"	5 9/32"
3-0	35 11/16"	6 9/32"

DOOR HEIGHT		
NOMINAL	ACTUAL	CYLINDRICAL PREP
6-8	79"	45 7/8"

GLASS OPTIONS	
SIZE	CUTOUT
22 x 48	23 x 49
15 x 39 oval*	16 x 40 oval

* Light frame required to verify cutout size

STEEL MARK® & STEEL MARK® PLUS

6'8" 2 PANEL 3/4 TOP

STEEL DOOR

WOOD EDGE | **STEEL MARK® & STEEL MARK® PLUS**
 STEEL EDGE | **STEEL MARK® & STEEL MARK® PLUS**

STEEL MARK® & STEEL MARK® PLUS

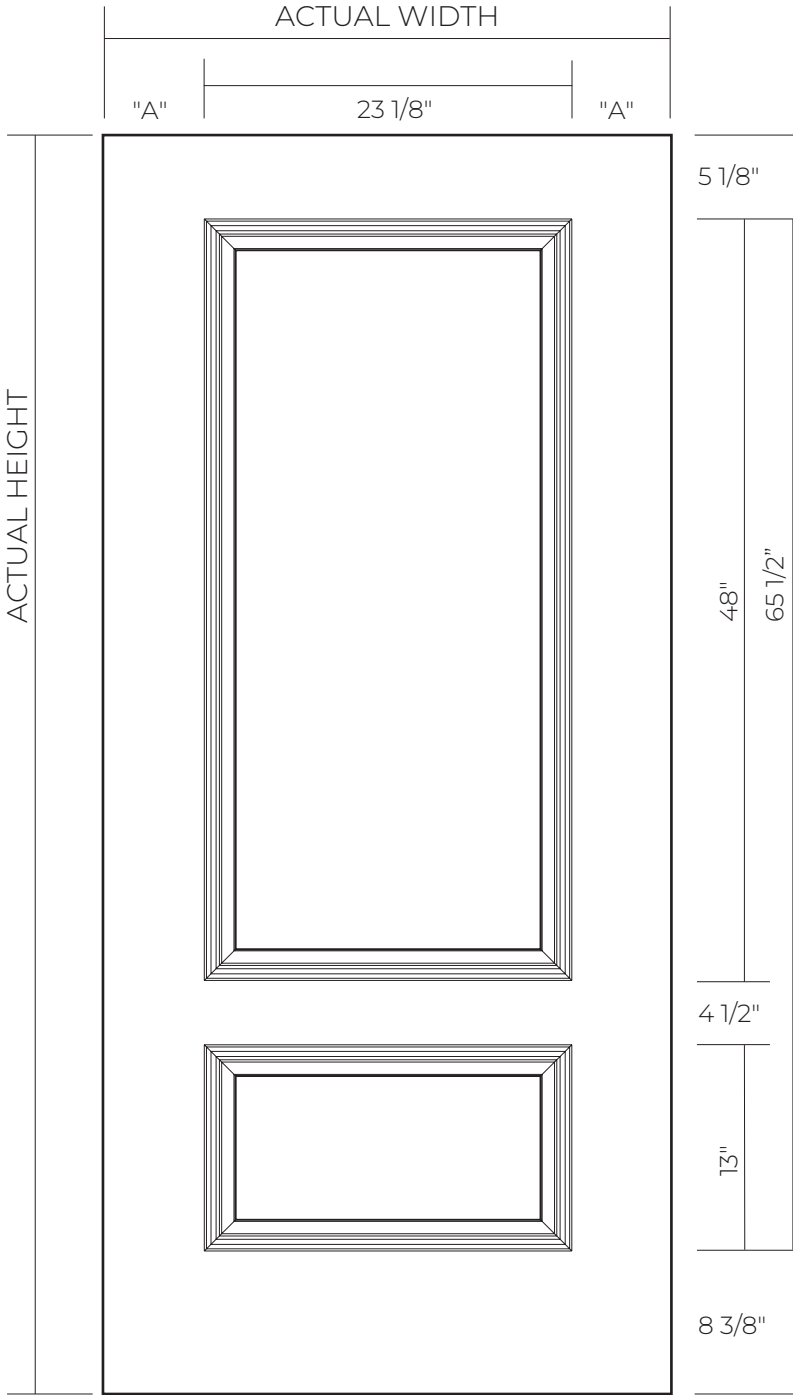

DOOR WIDTH - WOOD EDGE		
NOMINAL	ACTUAL	"A"
2-8	31 3/4"	4 5/16"
2-10	33 3/4"	5 5/16"
3-0	35 3/4"	6 5/16"

DOOR WIDTH - STEEL EDGE		
NOMINAL	ACTUAL	"A"
2-8	31 11/16"	4 9/32"
2-10	33 11/16"	5 9/32"
3-0	35 11/16"	6 9/32"

DOOR HEIGHT		
NOMINAL	ACTUAL	CYLINDRICAL PREP
6-8	79"	45 7/8"

GLASS OPTIONS	
SIZE	CUTOUT
22 x 48	23 x 49
22 x 64	23 x 65
14 x 37 oval**	15 x 38 oval
15 x 39 oval**	16 x 40 oval

** Light frame required to verify cutout size

6'8" 2 PANEL SQUARE

STEEL DOOR

WOOD EDGE | **STEEL MARK®** & **STEEL MARK® PLUS**
 STEEL EDGE | **STEEL MARK®** & **STEEL MARK® PLUS**

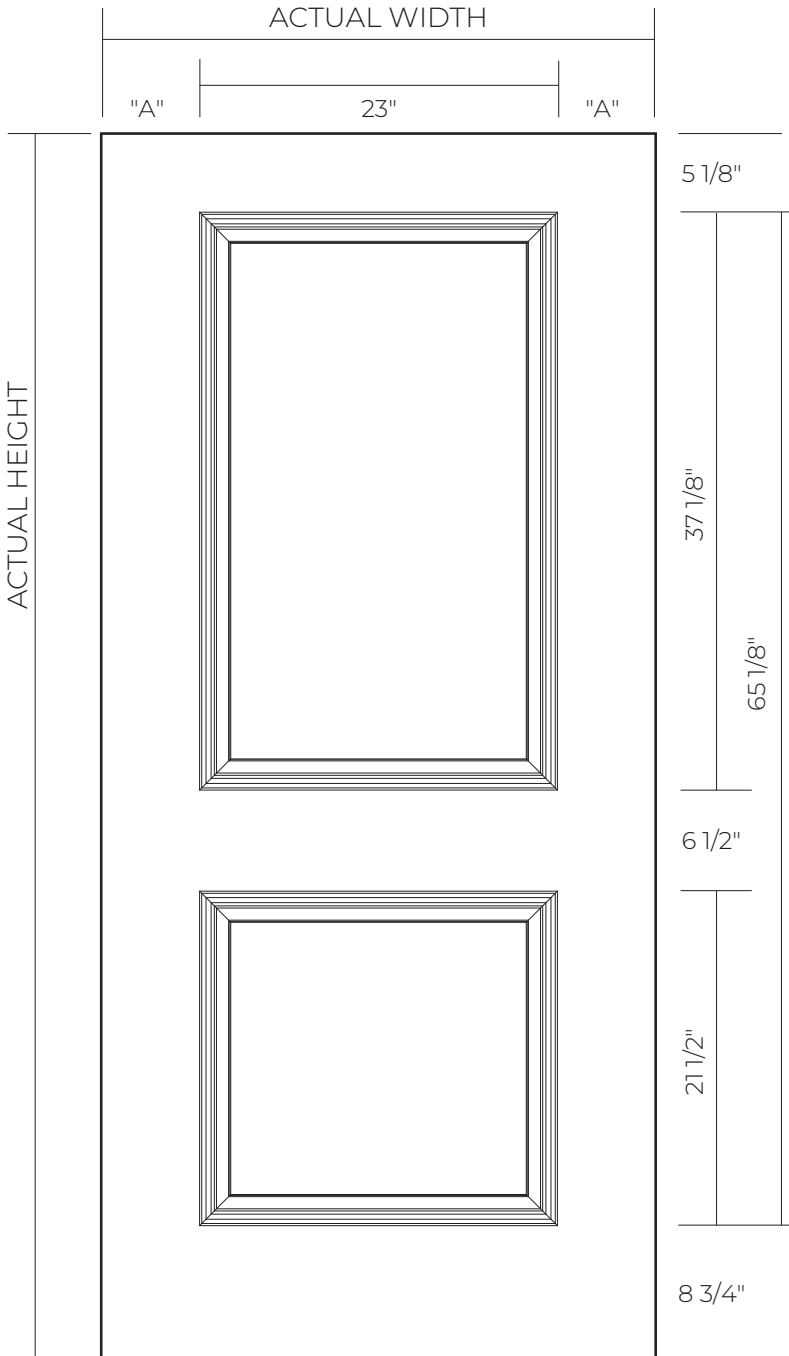

DOOR WIDTH - WOOD EDGE		
NOMINAL	ACTUAL	"A"
2-8	31 3/4"	4 3/8"
2-10	33 3/4"	5 3/8"
3-0	35 3/4"	6 3/8"

DOOR WIDTH - STEEL EDGE		
NOMINAL	ACTUAL	"A"
2-8	31 11/16"	4 11/32"
2-10	33 11/16"	5 11/32"
3-0	35 11/16"	6 11/32"

DOOR HEIGHT		
NOMINAL	ACTUAL	CYLINDRICAL PREP
6-8	79"	45 7/8"

GLASS OPTIONS	
SIZE	CUTOUT
22 x 36	23 x 37
22 x 64	23 x 65



STEEL MARK® & STEEL MARK® PLUS

6'8" 2 PANEL CAMBER

STEEL DOOR

WOOD EDGE | *STEEL MARK® & STEEL MARK® PLUS*
 STEEL EDGE | *STEEL MARK® & STEEL MARK® PLUS*

STEEL MARK® & STEEL MARK® PLUS

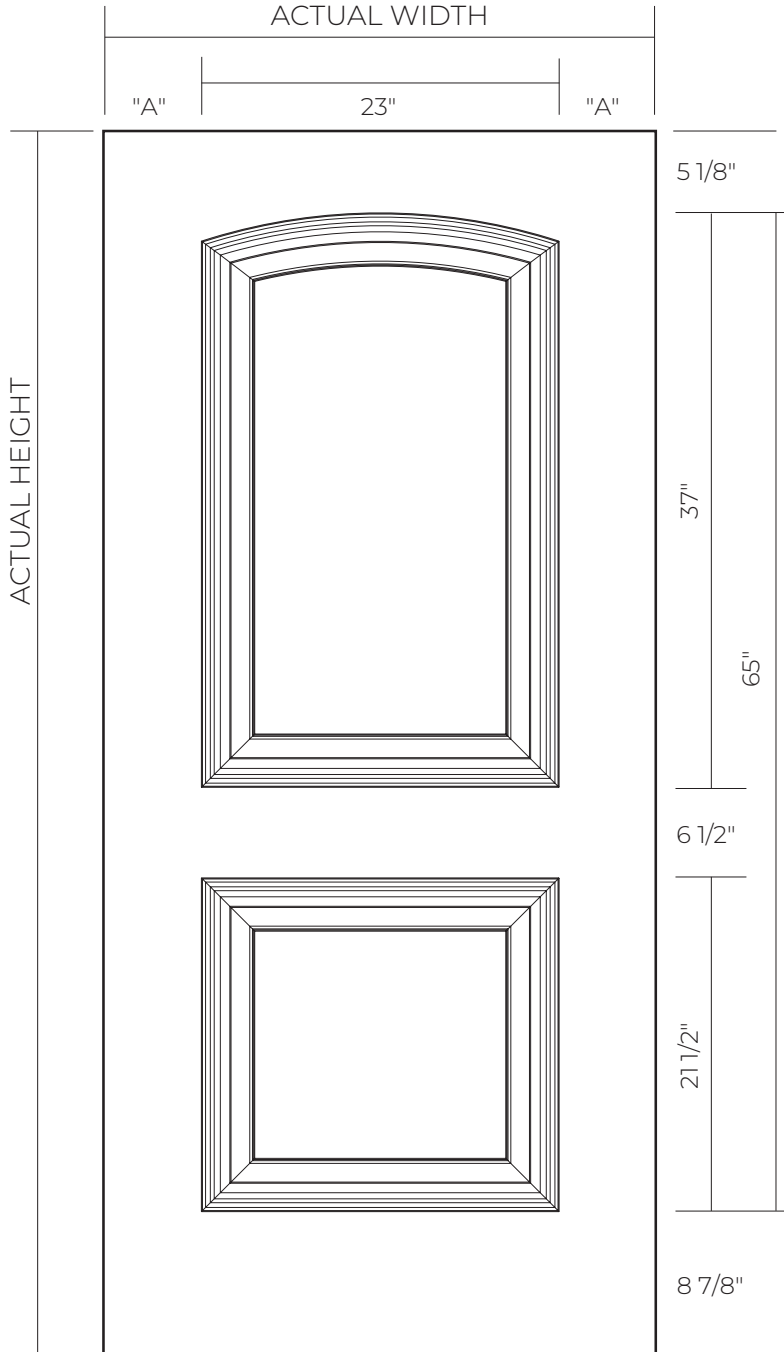

DOOR WIDTH - WOOD EDGE		
NOMINAL	ACTUAL	"A"
2-8	31 3/4"	4 3/8"
2-10	33 3/4"	5 3/8"
3-0	35 3/4"	6 3/8"

DOOR WIDTH - STEEL EDGE		
NOMINAL	ACTUAL	"A"
2-8	31 11/16"	4 11/32"
2-10	33 11/16"	5 11/32"
3-0	35 11/16"	6 11/32"

DOOR HEIGHT		
NOMINAL	ACTUAL	CYLINDRICAL PREP
6-8	79"	45 7/8"

GLASS OPTIONS	
SIZE	CUTOUT
22 x 36	23 x 37
22 x 64	23 x 65

6'8" 2 PANEL CAMBER PLANK

STEEL DOOR

WOOD EDGE | **STEEL MARK®** & **STEEL MARK® PLUS**
 STEEL EDGE | **STEEL MARK®** & **STEEL MARK® PLUS**

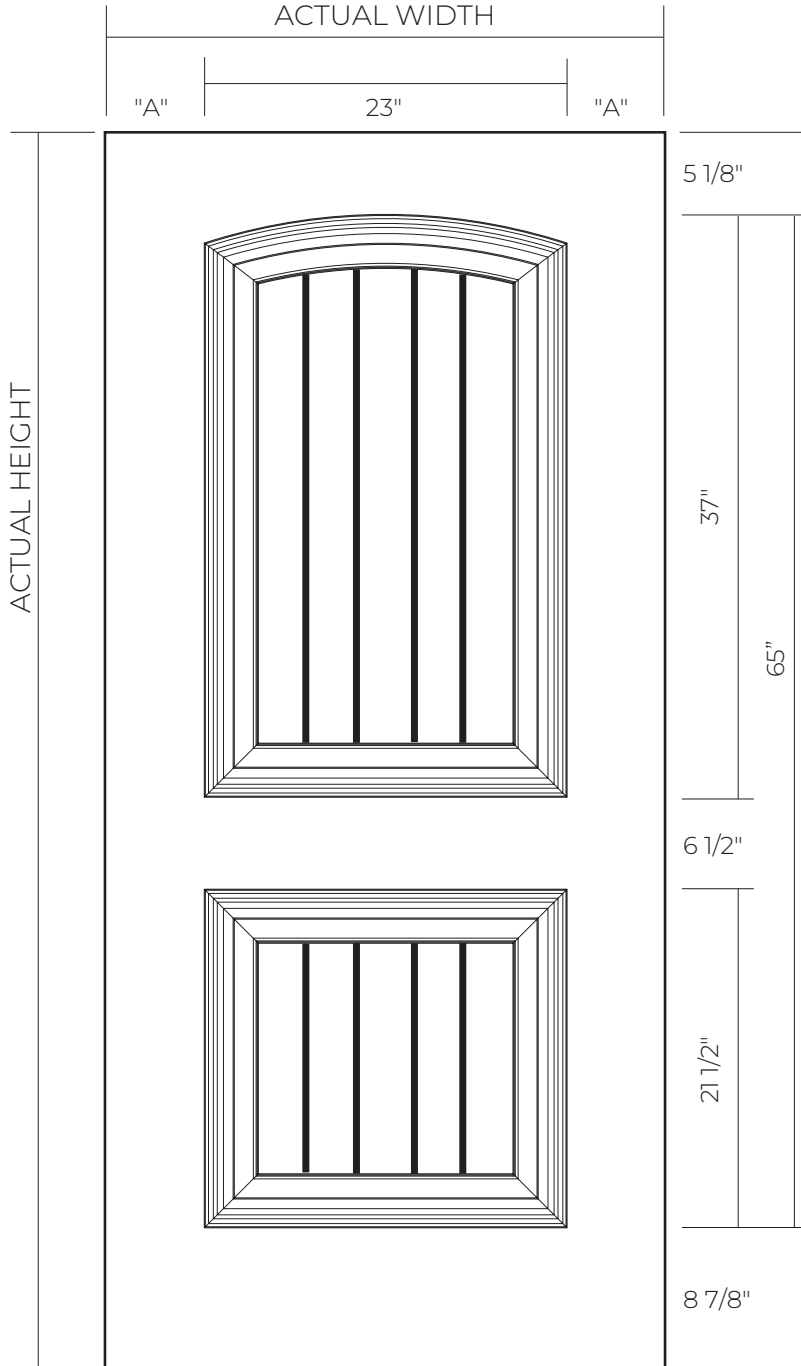

DOOR WIDTH - WOOD EDGE		
NOMINAL	ACTUAL	"A"
2-8	31 3/4"	4 3/8"
2-10	33 3/4"	5 3/8"
3-0	35 3/4"	6 3/8"

DOOR WIDTH - STEEL EDGE		
NOMINAL	ACTUAL	"A"
2-8	31 11/16"	4 11/32"
2-10	33 11/16"	5 11/32"
3-0	35 11/16"	6 11/32"

DOOR HEIGHT		
NOMINAL	ACTUAL	CYLINDRICAL PREP
6-8	79"	45 7/8"

GLASS OPTIONS	
SIZE	CUTOUT
22 x 36	23 x 37
22 x 64	23 x 65



STEEL MARK® & STEEL MARK® PLUS

6'8" EUROLINE 6

STEEL DOOR

WOOD EDGE | *STEEL MARK® & STEEL MARK® PLUS*
 STEEL EDGE | *STEEL MARK® & STEEL MARK® PLUS*

STEEL MARK® & STEEL MARK® PLUS

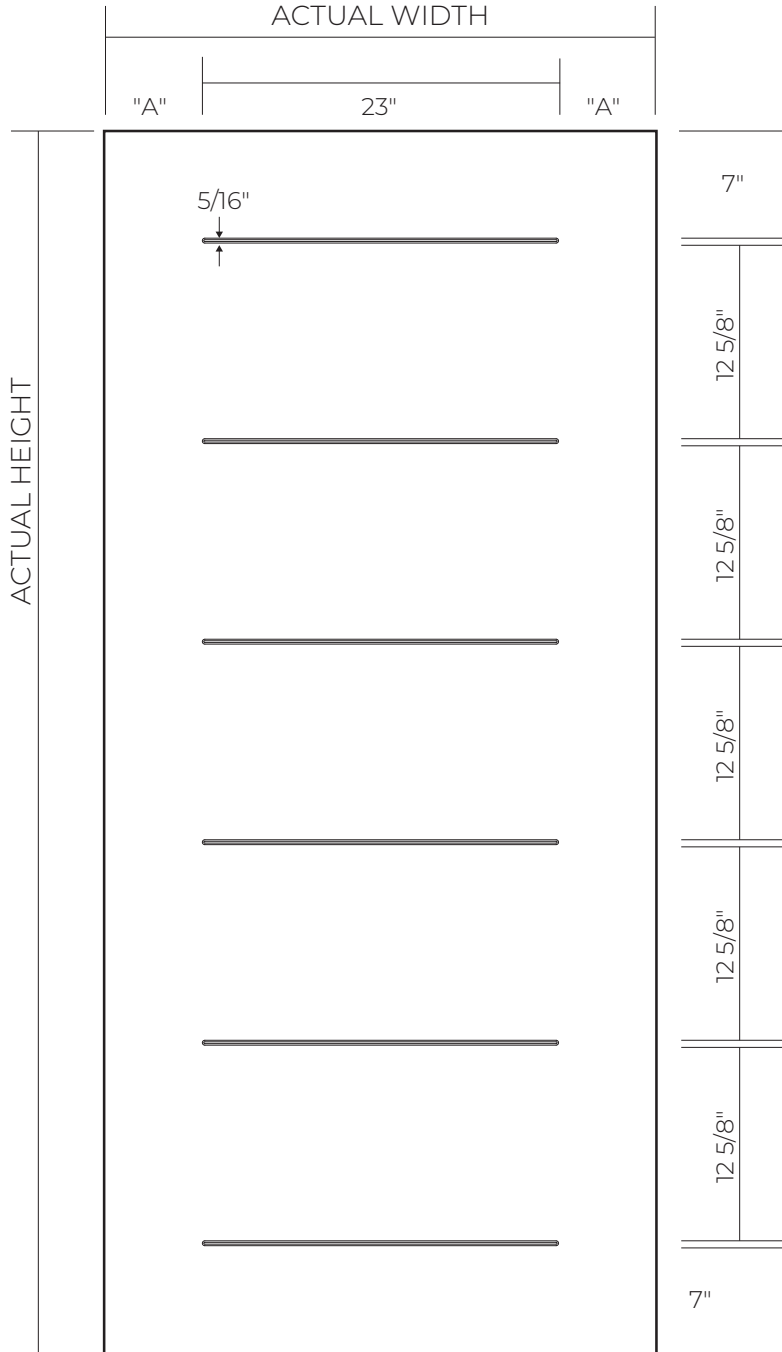

DOOR WIDTH - WOOD EDGE		
NOMINAL	ACTUAL	"A"
2-8	31 3/4"	4 3/8"
2-10	33 3/4"	5 3/8"
3-0	35 3/4"	6 3/8"

DOOR WIDTH - STEEL EDGE		
NOMINAL	ACTUAL	"A"
2-8	31 11/16"	4 11/32"
2-10	33 11/16"	5 11/32"
3-0	35 11/16"	6 11/32"

DOOR HEIGHT		
NOMINAL	ACTUAL	CYLINDRICAL PREP
6-8	79"	45 7/8"

6'8" 4 PANEL URBAN

STEEL DOOR

WOOD EDGE | **STEEL MARK® & STEEL MARK® PLUS**
 STEEL EDGE | **STEEL MARK® & STEEL MARK® PLUS**

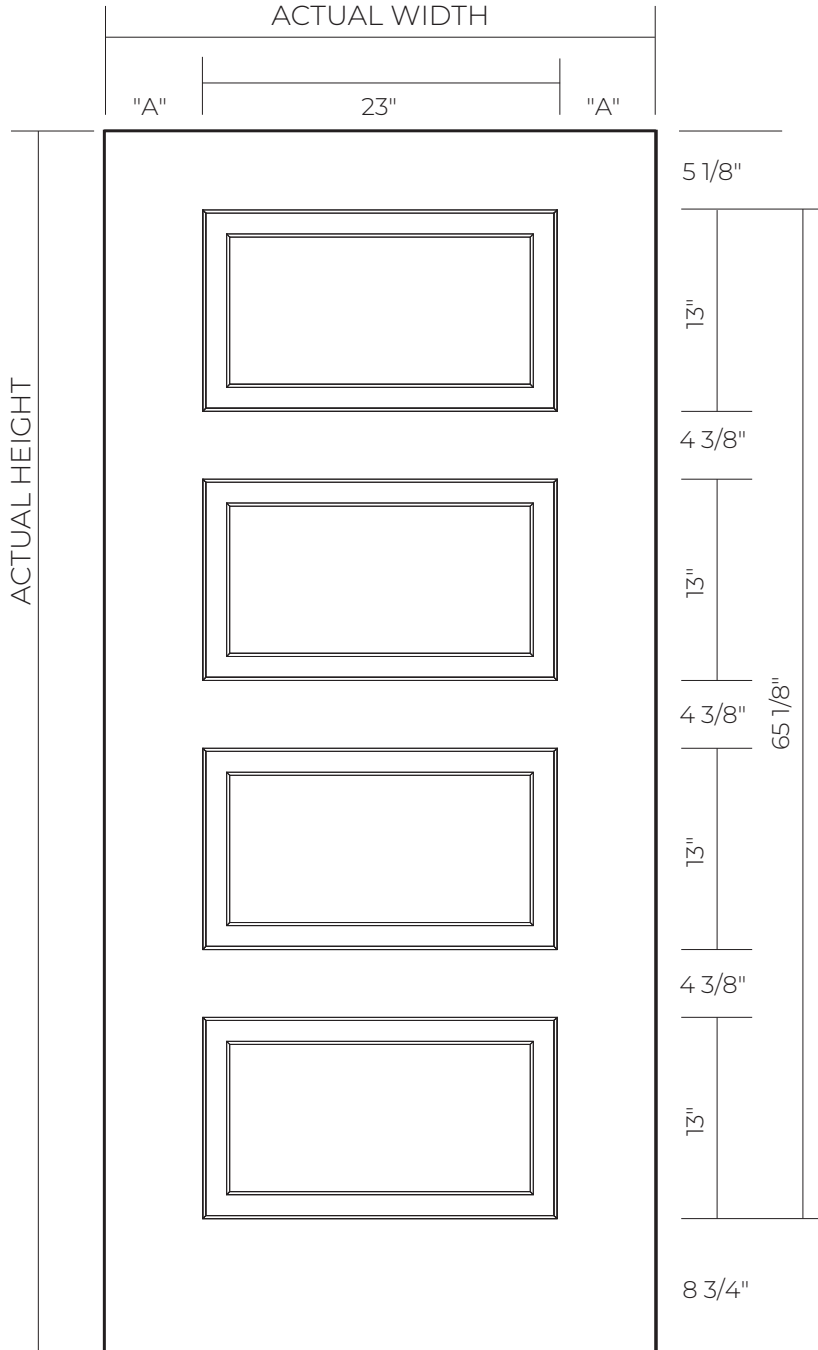

DOOR WIDTH - WOOD EDGE		
NOMINAL	ACTUAL	"A"
2-8	31 3/4"	4 3/8"
2-10	33 3/4"	5 3/8"
3-0	35 3/4"	6 3/8"

DOOR WIDTH - STEEL EDGE		
NOMINAL	ACTUAL	"A"
2-8	31 11/16"	4 11/32"
2-10	33 11/16"	5 11/32"
3-0	35 11/16"	6 11/32"

DOOR HEIGHT		
NOMINAL	ACTUAL	CYLINDRICAL PREP
6-8	79"	45 7/8"

GLASS OPTIONS	
SIZE	CUTOUT
22 x 48	23 x 49
22 x 64	23 x 65

STEEL MARK® & STEEL MARK® PLUS

6'8" 3 PANEL URBAN

STEEL DOOR

WOOD EDGE | **STEEL MARK® & STEEL MARK® PLUS**
 STEEL EDGE | **STEEL MARK® & STEEL MARK® PLUS**

STEEL MARK® & STEEL MARK® PLUS

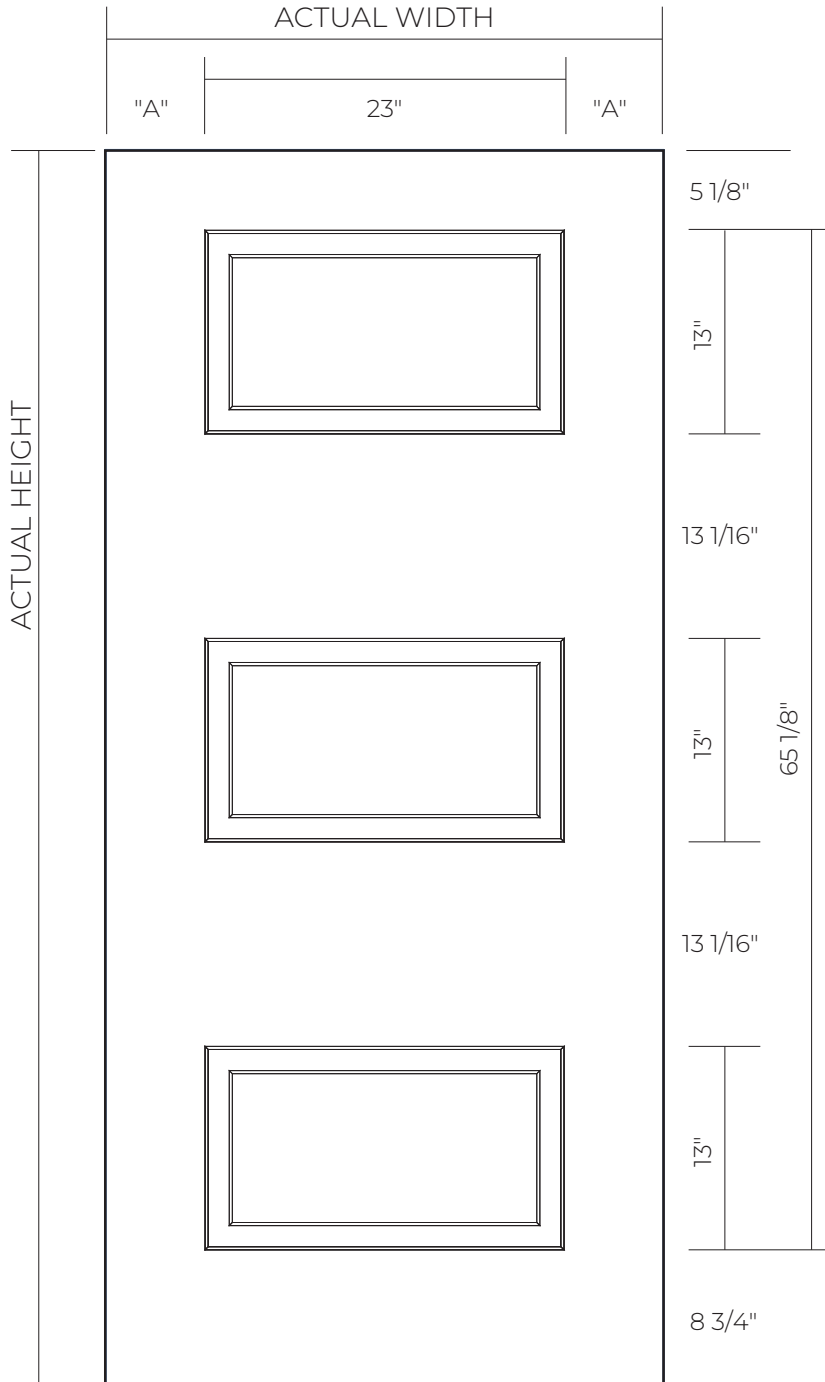

DOOR WIDTH - WOOD EDGE		
NOMINAL	ACTUAL	"A"
2-8	31 3/4"	4 3/8"
2-10	33 3/4"	5 3/8"
3-0	35 3/4"	6 3/8"

DOOR WIDTH - STEEL EDGE		
NOMINAL	ACTUAL	"A"
2-8	31 11/16"	4 11/32"
2-10	33 11/16"	5 11/32"
3-0	35 11/16"	6 11/32"

DOOR HEIGHT		
NOMINAL	ACTUAL	CYLINDRICAL PREP
6-8	79"	45 7/8"

GLASS OPTIONS	
SIZE	CUTOUT
22 x 48	23 x 49
22 x 64	23 x 65

6'8" 3 PANEL URBAN CRAFTSMAN

STEEL DOOR

WOOD EDGE | **STEEL MARK® & STEEL MARK® PLUS**
 STEEL EDGE | **STEEL MARK® & STEEL MARK® PLUS**

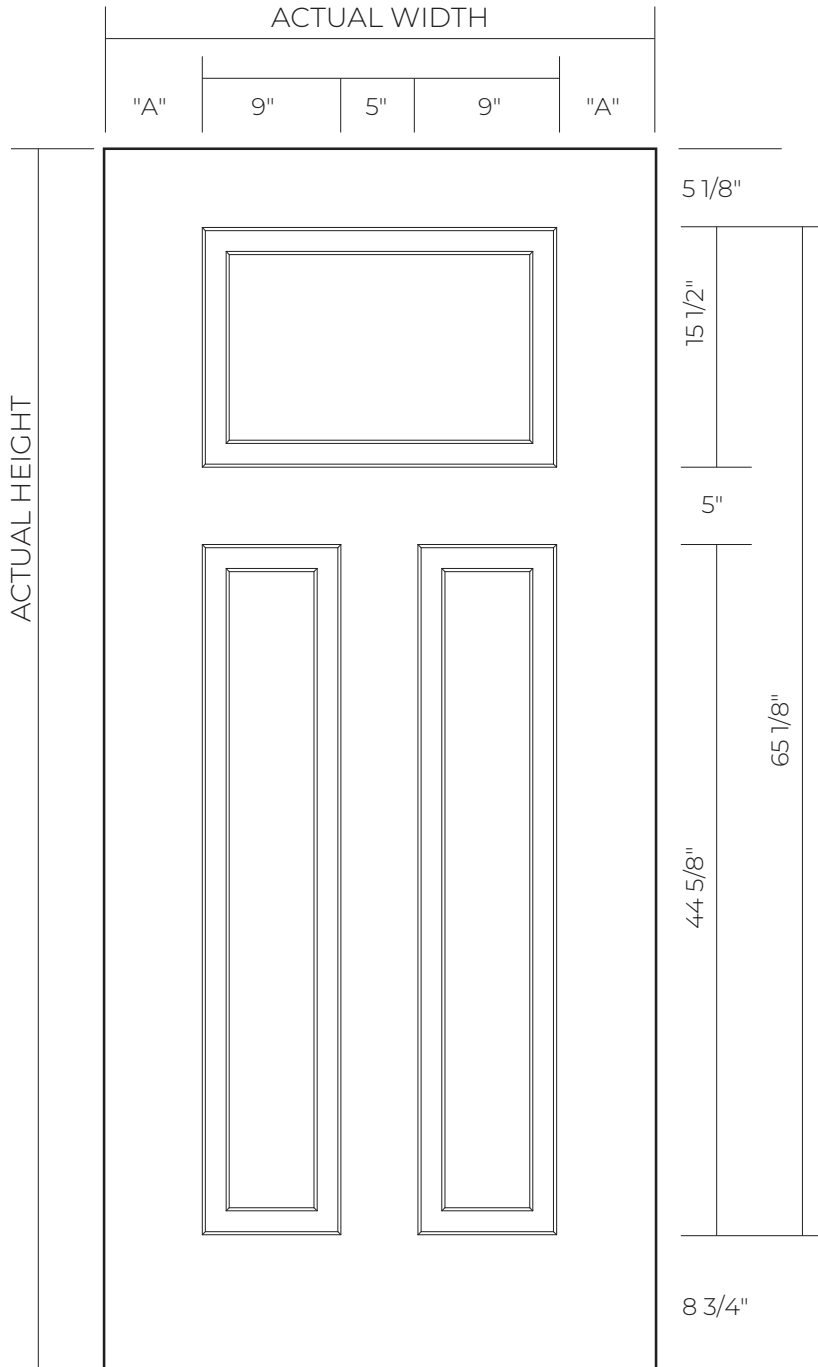

DOOR WIDTH - WOOD EDGE		
NOMINAL	ACTUAL	"A"
2-8	31 3/4"	4 3/8"
2-10	33 3/4"	5 3/8"
3-0	35 3/4"	6 3/8"

DOOR WIDTH - STEEL EDGE		
NOMINAL	ACTUAL	"A"
2-8	31 11/16"	4 11/32"
2-10	33 11/16"	5 11/32"
3-0	35 11/16"	6 11/32"

DOOR HEIGHT		
NOMINAL	ACTUAL	CYLINDRICAL PREP
6-8	79"	45 7/8"

GLASS OPTIONS	
SIZE	CUTOUT
22 x 15 1/4	23x 16 1/4
22 x 64	23 x 65

STEEL MARK® & STEEL MARK® PLUS

6'8" FLUSH

STEEL SIDELIGHT

WOOD EDGE | *STEEL MARK®* & *STEEL MARK® PLUS*

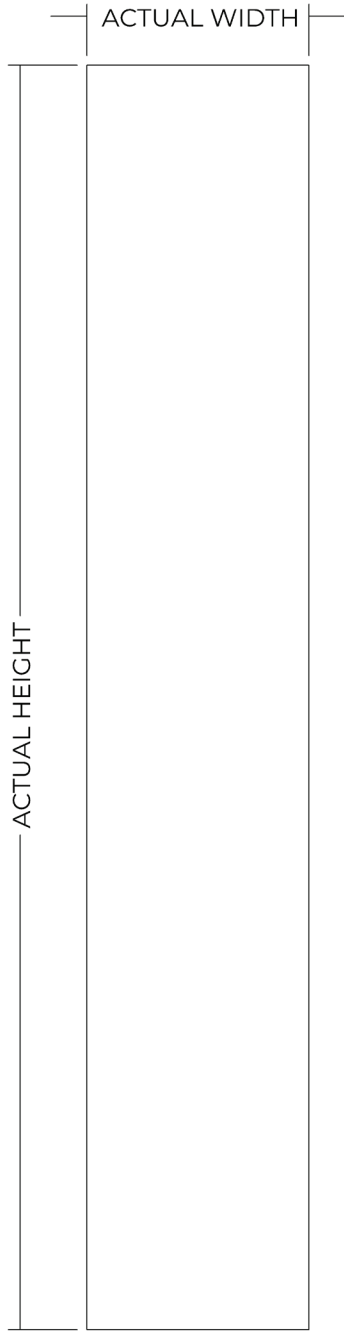

SIDELIGHT WIDTH - WOOD EDGE

NOMINAL	ACTUAL
1-0	11 7/8"
1-2	13 7/8"
1-6	17 7/8"

DOOR HEIGHT

NOMINAL	ACTUAL
6-8	79"

GLASS OPTIONS

SIZE	CUTOUT
7 x 64	8 x 65
8 x 64	9 x 65

6'8" 2 PANEL REVERSE

STEEL SIDELIGHT

WOOD EDGE | **STEEL MARK®** & **STEEL MARK® PLUS**

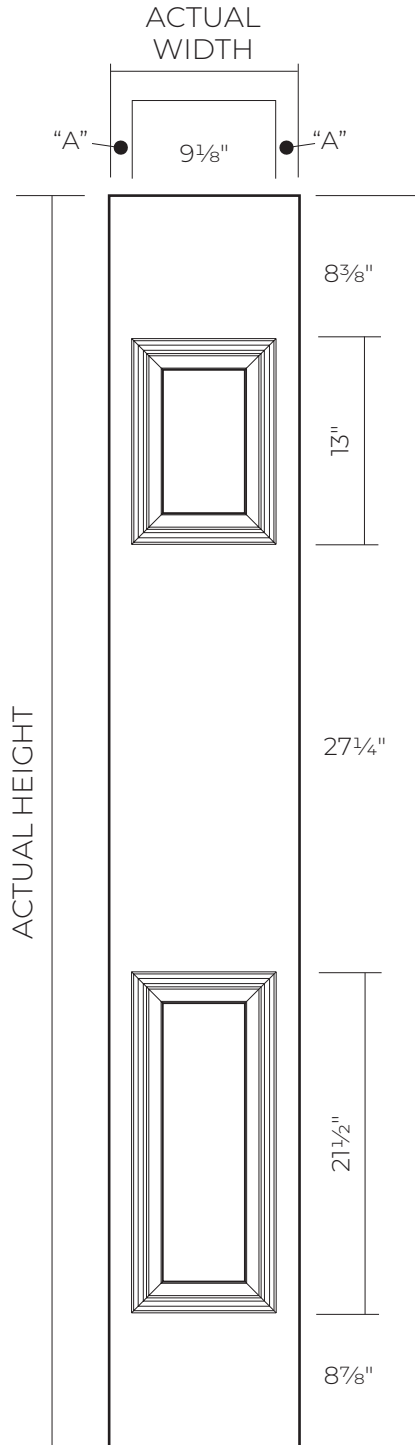

SIDELIGHT WIDTH - WOOD EDGE		
NOMINAL	ACTUAL	"A"
1-0	11 7/8"	1 7/16"
1-2	13 7/8"	2 7/16"
1-6	17 7/8"	4 7/16"

DOOR HEIGHT	
NOMINAL	ACTUAL
6-8	79"

GLASS OPTIONS	
SIZE	CUTOUT
8 x 36	9 x 37
8 x 64	9 x 65

STEEL MARK® & STEEL MARK® PLUS

6'8" 2 PANEL REVERSE

STEEL SIDELIGHT

WOOD EDGE | STEEL MARK® & STEEL MARK® PLUS

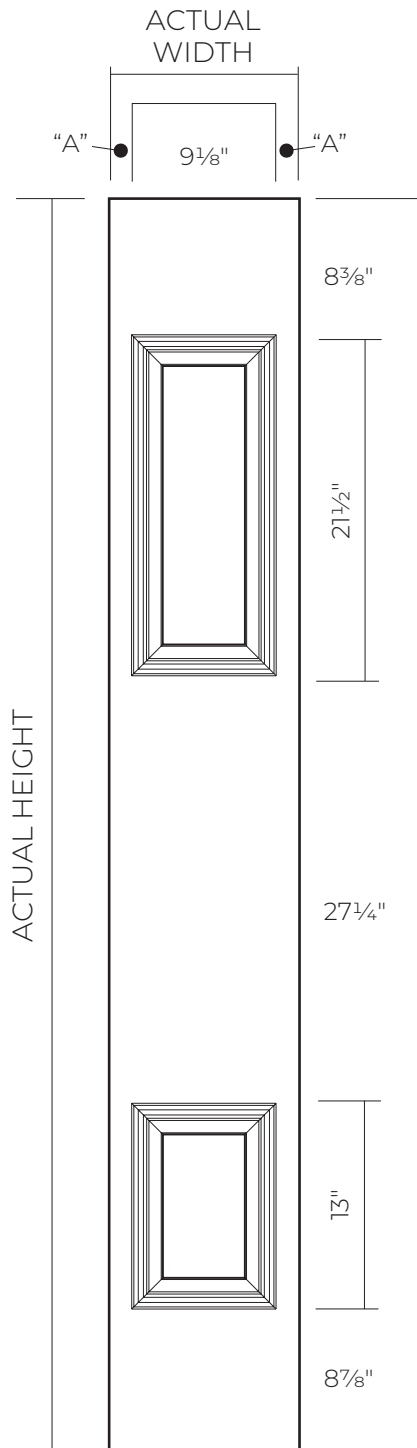

SIDELIGHT WIDTH - WOOD EDGE		
NOMINAL	ACTUAL	"A"
1-0	11 7/8"	1 7/16"
1-2	13 7/8"	2 7/16"
1-6	17 7/8"	4 7/16"

DOOR HEIGHT	
NOMINAL	ACTUAL
6-8	79"

GLASS OPTIONS	
SIZE	CUTOUT
8 x 48	9 x 49
8 x 64	9 x 65

6'8" FLUSH w/1 LIGHT CUTOUT

STEEL SIDELIGHT

WOOD EDGE | **STEEL MARK®** & **STEEL MARK® PLUS**

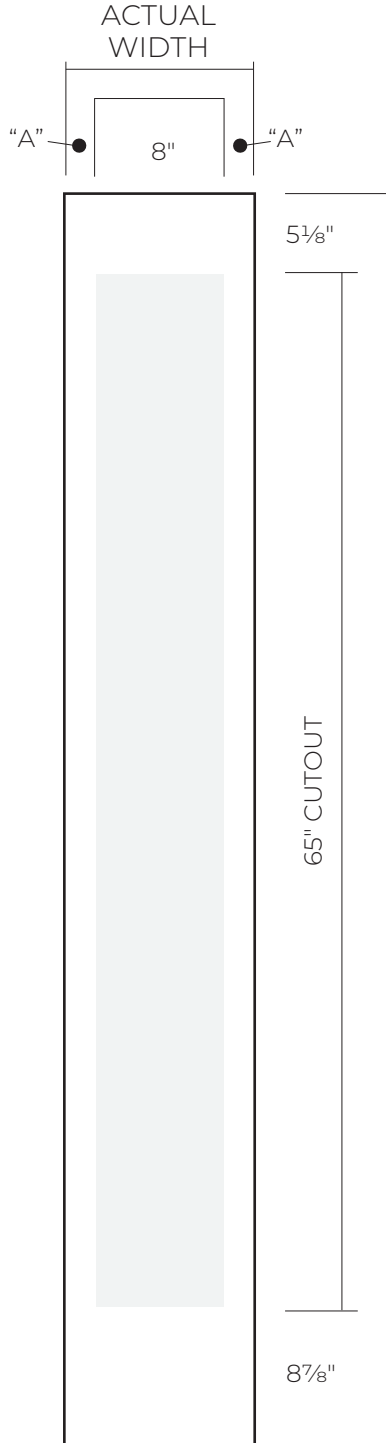

SIDELIGHT WIDTH - WOOD EDGE		
NOMINAL	ACTUAL	"A"
1-0	11 7/8"	1 7/16"
1-2	13 7/8"	2 7/16"
1-6	17 7/8"	4 7/16"

DOOR HEIGHT	
NOMINAL	ACTUAL
6-8	79"

GLASS OPTIONS	
SIZE	CUTOUT
7 x 64	8 x 65

STEEL MARK® & STEEL MARK® PLUS

6'8" 3/4 LIGHT w/9x49 CUTOUT

STEEL SIDELIGHT

WOOD EDGE | STEEL MARK® & STEEL MARK® PLUS

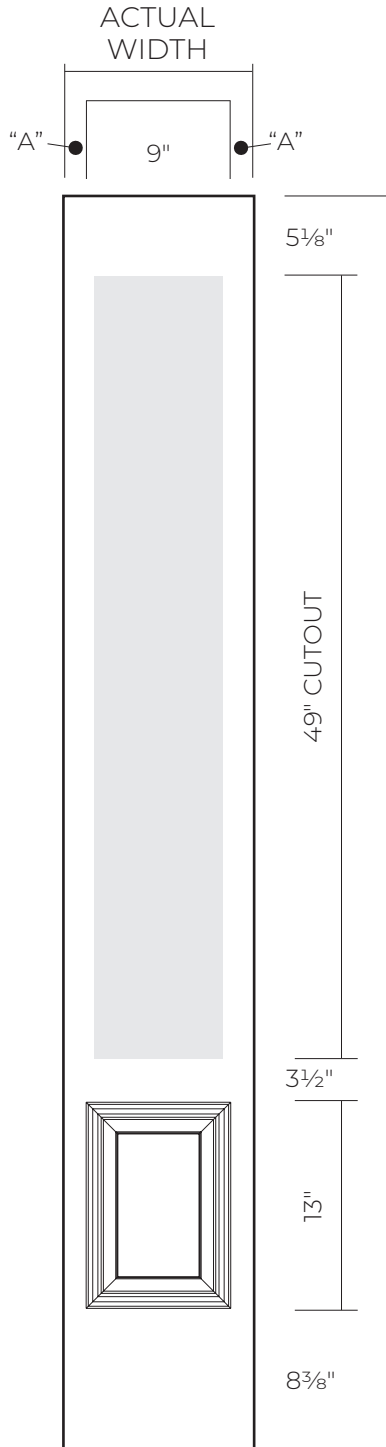

SIDELIGHT WIDTH - WOOD EDGE		
NOMINAL	ACTUAL	"A"
1-0	11 ⁷ / ₈ "	1 7/16"
1-2	13 ⁷ / ₈ "	2 7/16"
1-6	17 ⁷ / ₈ "	4 7/16"

DOOR HEIGHT	
NOMINAL	ACTUAL
6-8	79"

GLASS OPTIONS	
SIZE	CUTOUT
8 x 48	9 x 49

6'8" 1/2 LIGHT w/9x37 CUTOUT

STEEL SIDELIGHT

WOOD EDGE | STEEL MARK® & STEEL MARK® PLUS

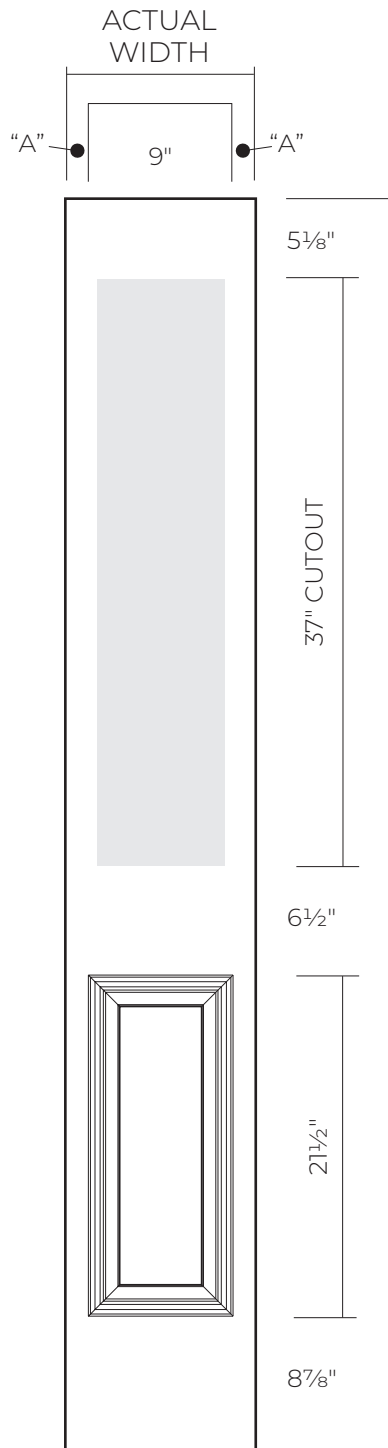

SIDELIGHT WIDTH - WOOD EDGE

NOMINAL	ACTUAL	"A"
1-0	1 1/8"	1 7/16"
1-2	1 3/8"	2 7/16"
1-6	1 7/8"	4 7/16"

DOOR HEIGHT

NOMINAL	ACTUAL
6-8	79"

GLASS OPTIONS

SIZE	CUTOUT
8 x 36	9 x 37

STEEL MARK® & STEEL MARK® PLUS

6'8" 3/4 URBAN w/9x49 CUTOUT

STEEL SIDELIGHT

WOOD EDGE | STEEL MARK® & STEEL MARK® PLUS

STEEL MARK® & STEEL MARK® PLUS

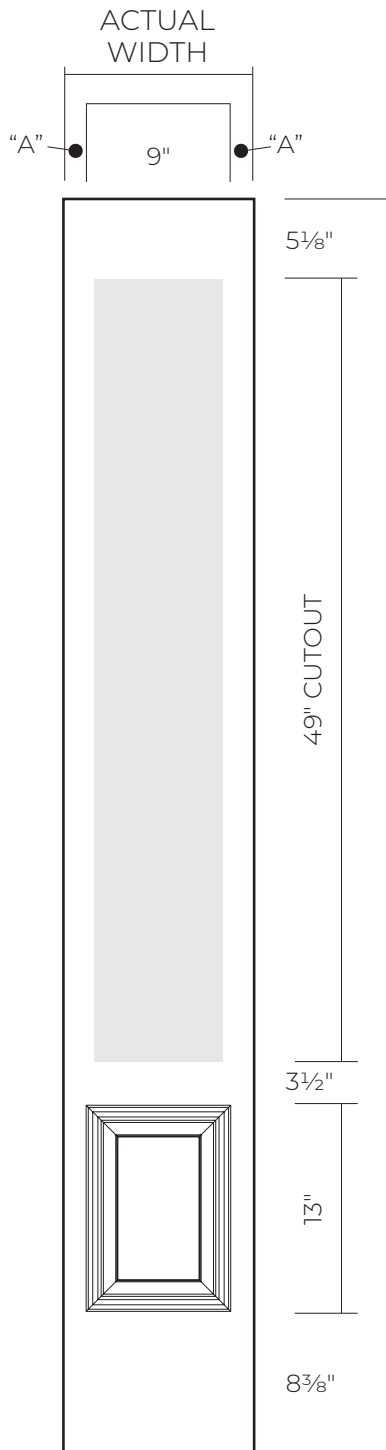

SIDELIGHT WIDTH - WOOD EDGE

NOMINAL	ACTUAL	"A"
1-0	1 1/8"	1 15/32"
1-2	1 3/8"	2 15/32"
1-6	1 7/8"	4 15/32"

DOOR HEIGHT

NOMINAL	ACTUAL
6-8	79"

GLASS OPTIONS

SIZE	CUTOUT
8 x 48	9 x 49

6'8" 1/4 URBAN w/9x15 1/2 CUTOUT

STEEL SIDELIGHT

WOOD EDGE | **STEEL MARK®** & **STEEL MARK® PLUS**

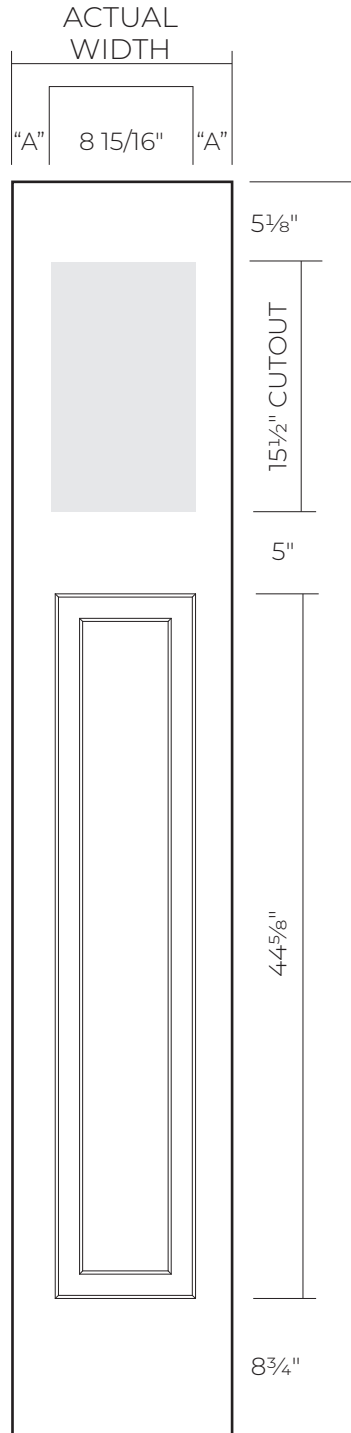

SIDELIGHT WIDTH - WOOD EDGE		
NOMINAL	ACTUAL	"A"
1-0	11 7/8"	1 15/32"
1-2	13 7/8"	2 15/32"
1-6	17 7/8"	4 15/32"

DOOR HEIGHT	
NOMINAL	ACTUAL
6-8	79"

GLASS OPTIONS	
SIZE	CUTOUT
8 x 17	9 x 18

STEEL MARK® & STEEL MARK® PLUS

7'0" FLUSH

STEEL DOOR

WOOD EDGE | **STEEL MARK®** & **STEEL MARK® PLUS**

STEEL MARK® & STEEL MARK® PLUS

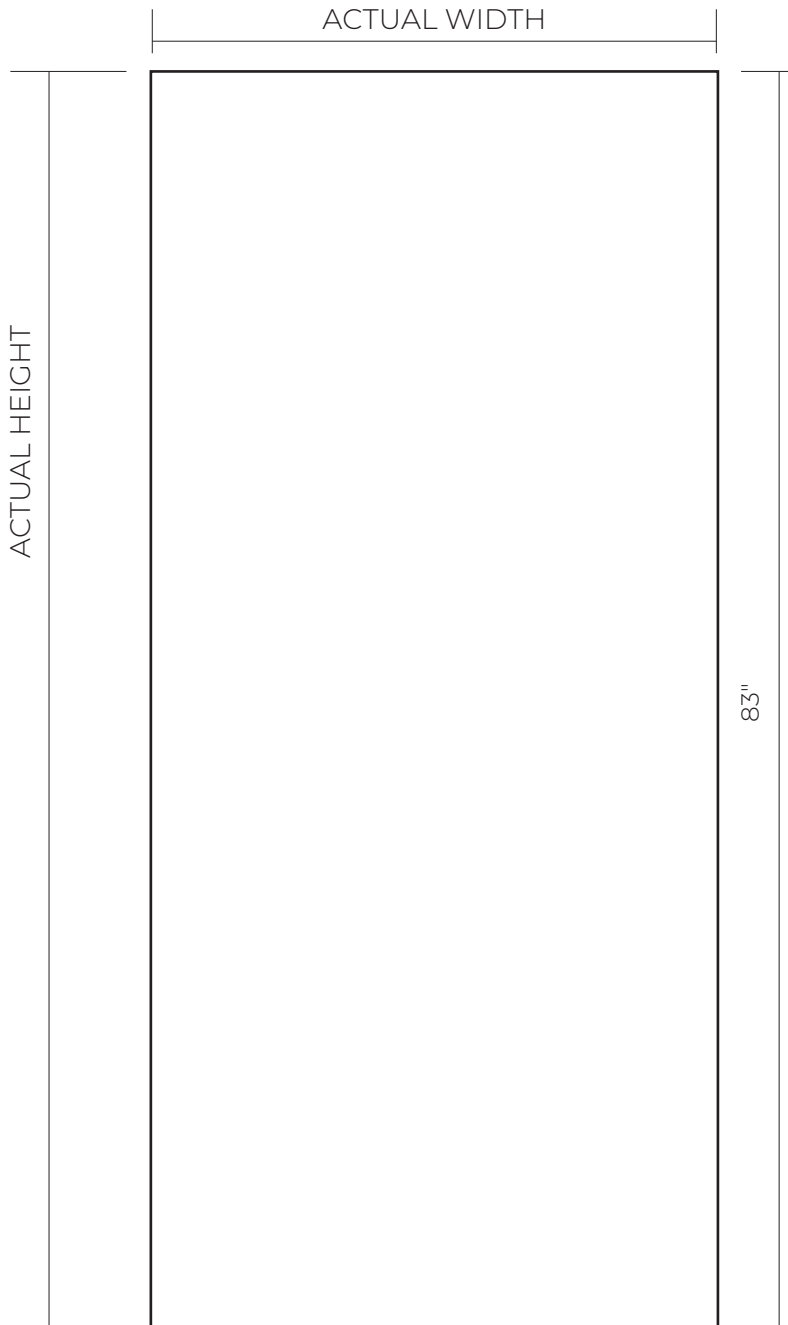

DOOR WIDTH - WOOD EDGE

NOMINAL	ACTUAL
2-6	29 3/4"
2-8	31 3/4"
2-10	33 3/4"
3-0	35 3/4"
3-6	41 3/4"

DOOR HEIGHT

NOMINAL	ACTUAL	CYLINDRICAL PREP
7-0	83"	49 7/8"

GLASS OPTIONS

SIZE	CUTOUT
8 x 6	9 x 7
8 x 36	9 x 37
7 x 64	8 x 65
8 x 64	9 x 65
22 x 10	23 x 11
22 x 36	23 x 37
22 x 48	23 x 49
22 x 64	23 x 65
22 x 17	23 x 18

GARDEN DOOR SIZES AVAILABLE

7'0" 6 PANEL

STEEL DOOR

WOOD EDGE | **STEEL MARK®** & **STEEL MARK® PLUS**

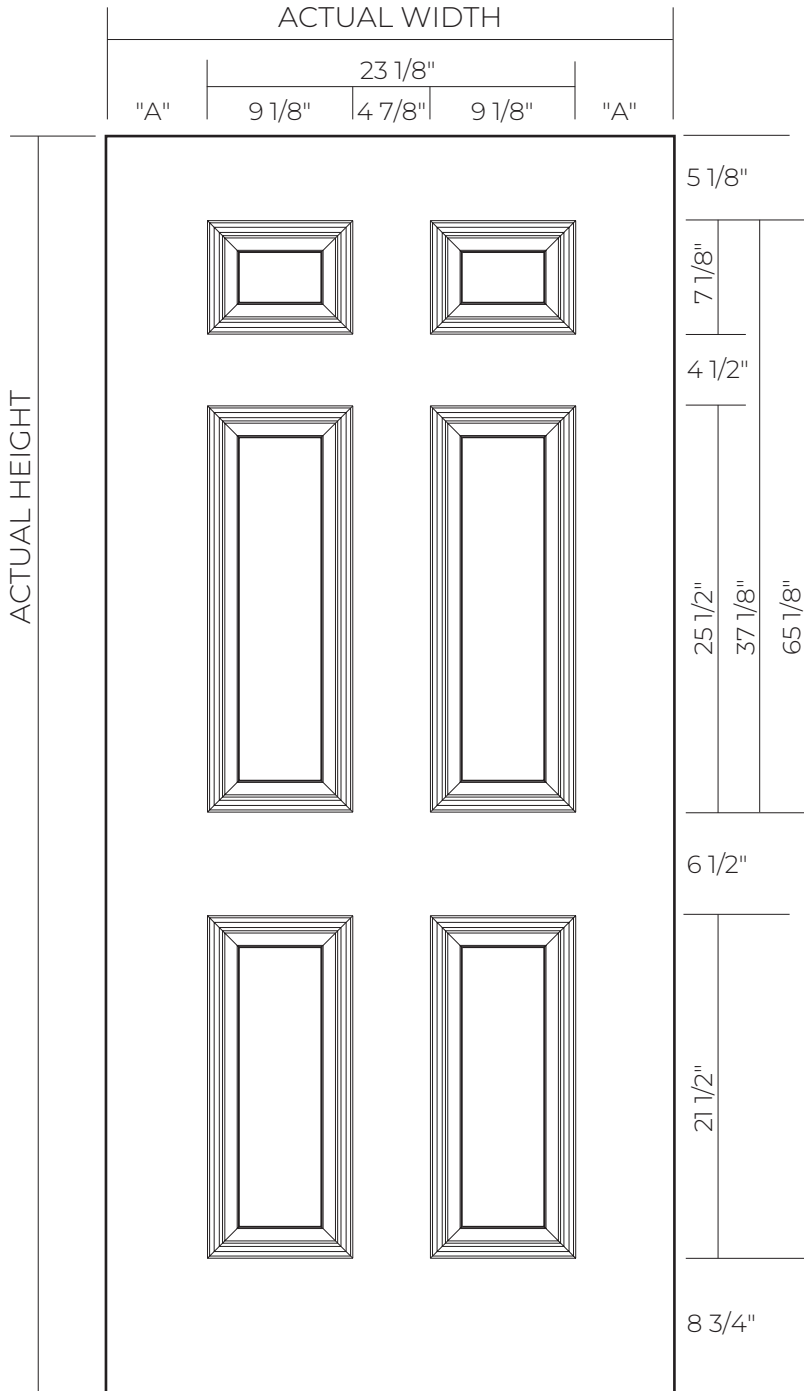

DOOR WIDTH - WOOD EDGE		
NOMINAL	ACTUAL	"A"
2-8	31 3/4"	4 5/16"
2-10	33 3/4"	5 5/16"
3-0	35 3/4"	6 5/16"

DOOR HEIGHT		
NOMINAL	ACTUAL	CYLINDRICAL PREP
7-0	83"	49 7/8"

GLASS OPTIONS	
SIZE	CUTOUT
8 x 6	9 x 7
8 x 36	9 x 37
22 x 10	23 x 11
22 x 36	23 x 37
22 x 64	23 x 65



STEEL MARK® & STEEL MARK® PLUS

7'0" 4 PANEL

STEEL DOOR

WOOD EDGE | *STEEL MARK®* & *STEEL MARK® PLUS*

STEEL MARK® & STEEL MARK® PLUS

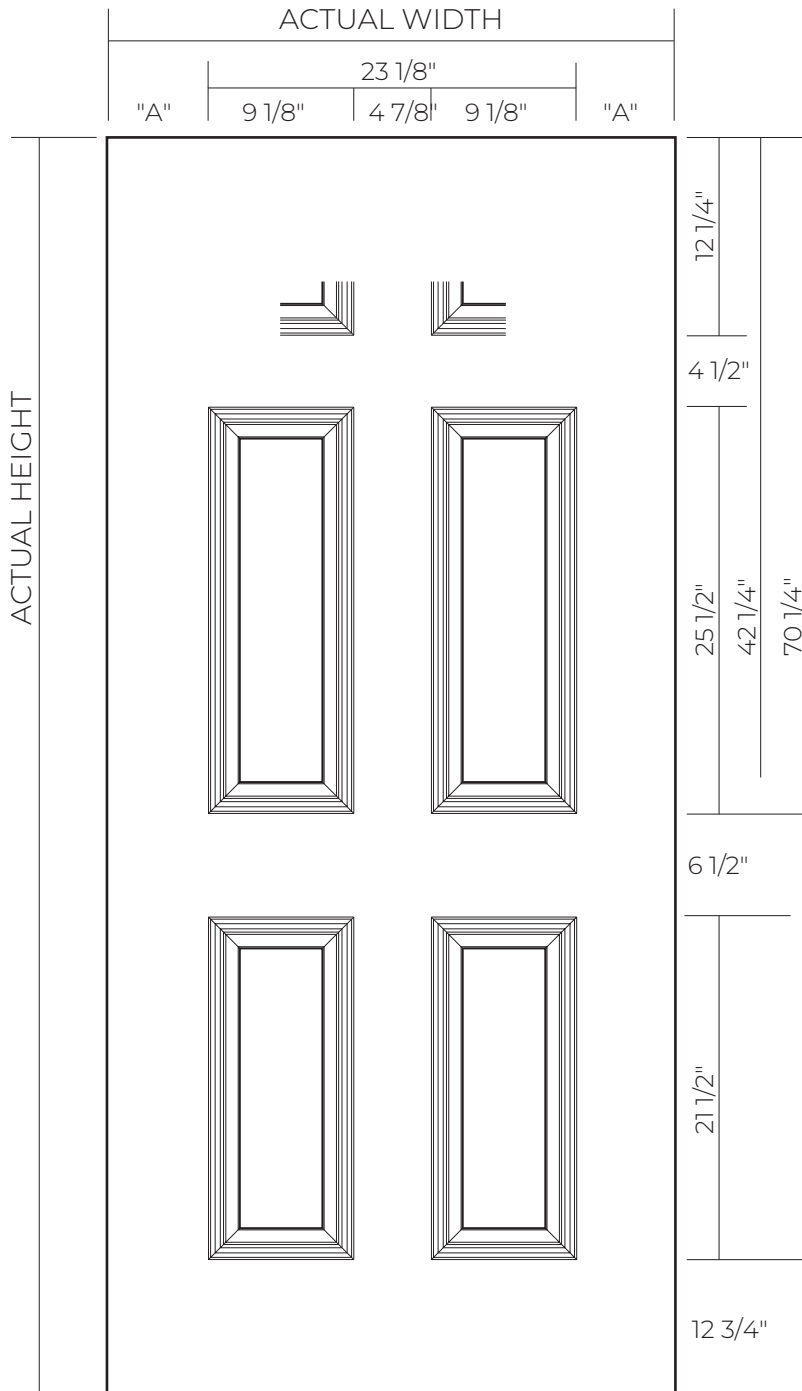

DOOR WIDTH - WOOD EDGE		
NOMINAL	ACTUAL	"A"
2-8	31 3/4"	4 5/16"
2-10	33 3/4"	5 5/16"
3-0	35 3/4"	6 5/16"

DOOR HEIGHT		
NOMINAL	ACTUAL	CYLINDRICAL PREP
7-0	83"	49 7/8"

GLASS OPTIONS	
SIZE	CUTOUT
8 x 6	9 x 7
8 x 36	9 x 37
8 x 36 RT*	9 x 37 RT
22 x 10 HR*	23 x 11 HR
22 x 36	23 x 37
22 x 36 RT*	23 x 37 RT
22 x 64	23 x 65

* Light frame required to verify cutout size

7'0" 2 PANEL 3/4 TOP

STEEL DOOR

WOOD EDGE | STEEL MARK® & STEEL MARK® PLUS

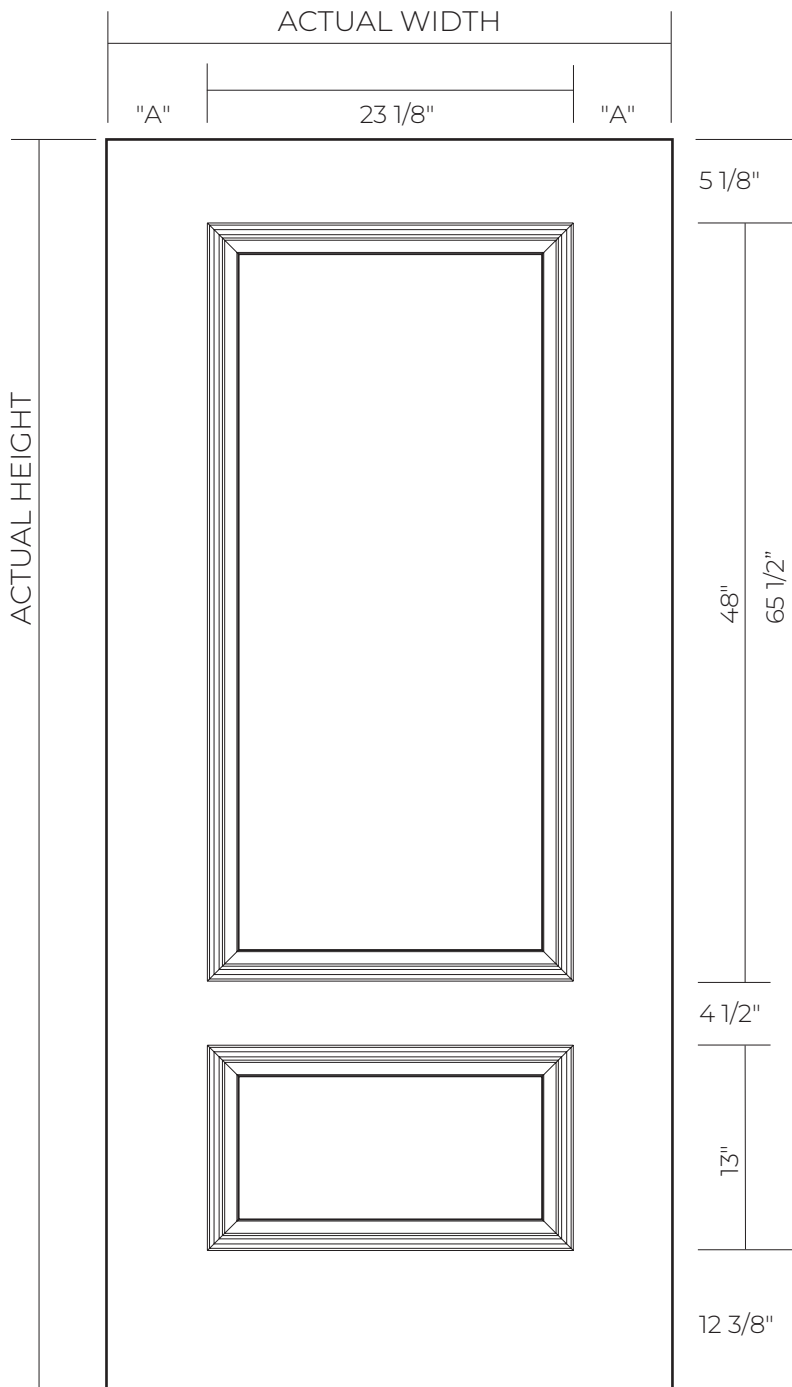

DOOR WIDTH - WOOD EDGE

NOMINAL	ACTUAL	"A"
2-8	31 3/4"	4 5/16"
2-10	33 3/4"	5 5/16"
3-0	35 3/4"	6 5/16"

DOOR HEIGHT

NOMINAL	ACTUAL	CYLINDRICAL PREP
7-0	83"	49 7/8"

GLASS OPTIONS

SIZE	CUTOUT
22 x 48	23 x 49
22 x 64	23 x 65

STEEL MARK® & STEEL MARK® PLUS

7'0" FLUSH

STEEL SIDELIGHT

WOOD EDGE | **STEEL MARK®** & **STEEL MARK® PLUS**

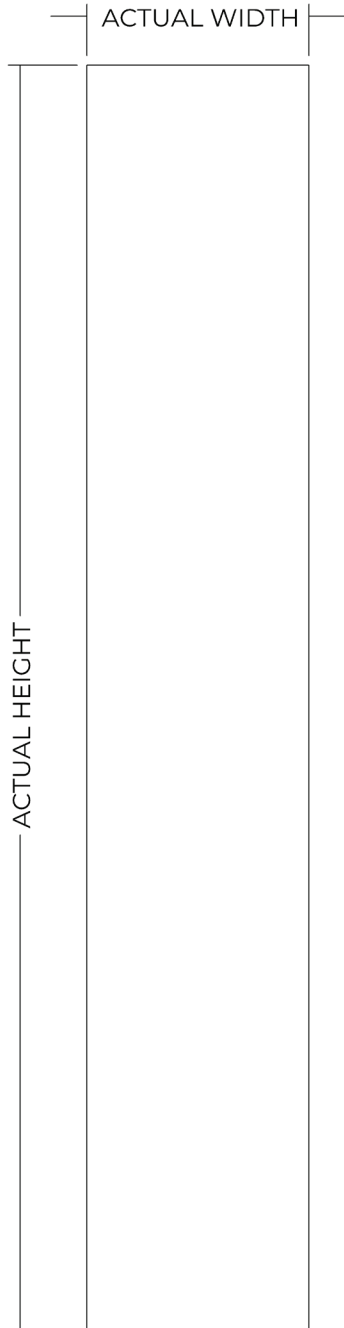

SIDELIGHT WIDTH - WOOD EDGE	
NOMINAL	ACTUAL
1-0	11 ⁷ / ₈ "
1-2	13 ⁷ / ₈ "
1-6	17 ⁷ / ₈ "

DOOR HEIGHT	
NOMINAL	ACTUAL
6-8	79"
7-0	83"

GLASS OPTIONS	
SIZE	CUTOUT
7 x 64	8 x 65
8 x 64	9 x 65

8'0" FLUSH

STEEL DOOR

WOOD EDGE | *STEEL MARK®* & *STEEL MARK® PLUS*

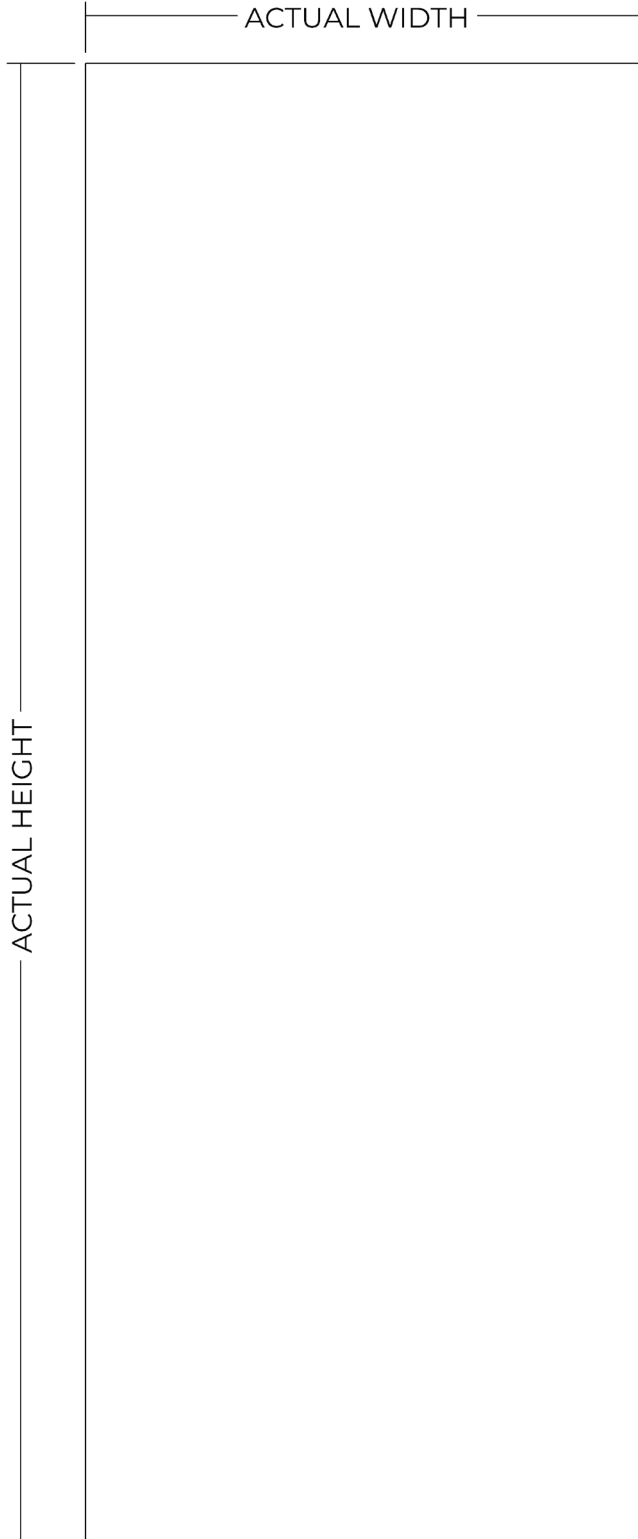

DOOR WIDTH - WOOD EDGE

NOMINAL	ACTUAL
2-6	29 3/4"
2-8	31 3/4"
2-10	33 3/4"
3-0	35 3/4"
3-6	41 3/4"

DOOR HEIGHT

NOMINAL	ACTUAL	CYLINDRICAL PREP
8-0	95"	59"

GLASS OPTIONS

SIZE	CUTOUT
22 x 80	23 x 81

STEEL MARK® & STEEL MARK® PLUS

8'0" 6 PANEL

STEEL DOOR

WOOD EDGE | *STEEL MARK®* & *STEEL MARK® PLUS*

STEEL MARK® & STEEL MARK® PLUS

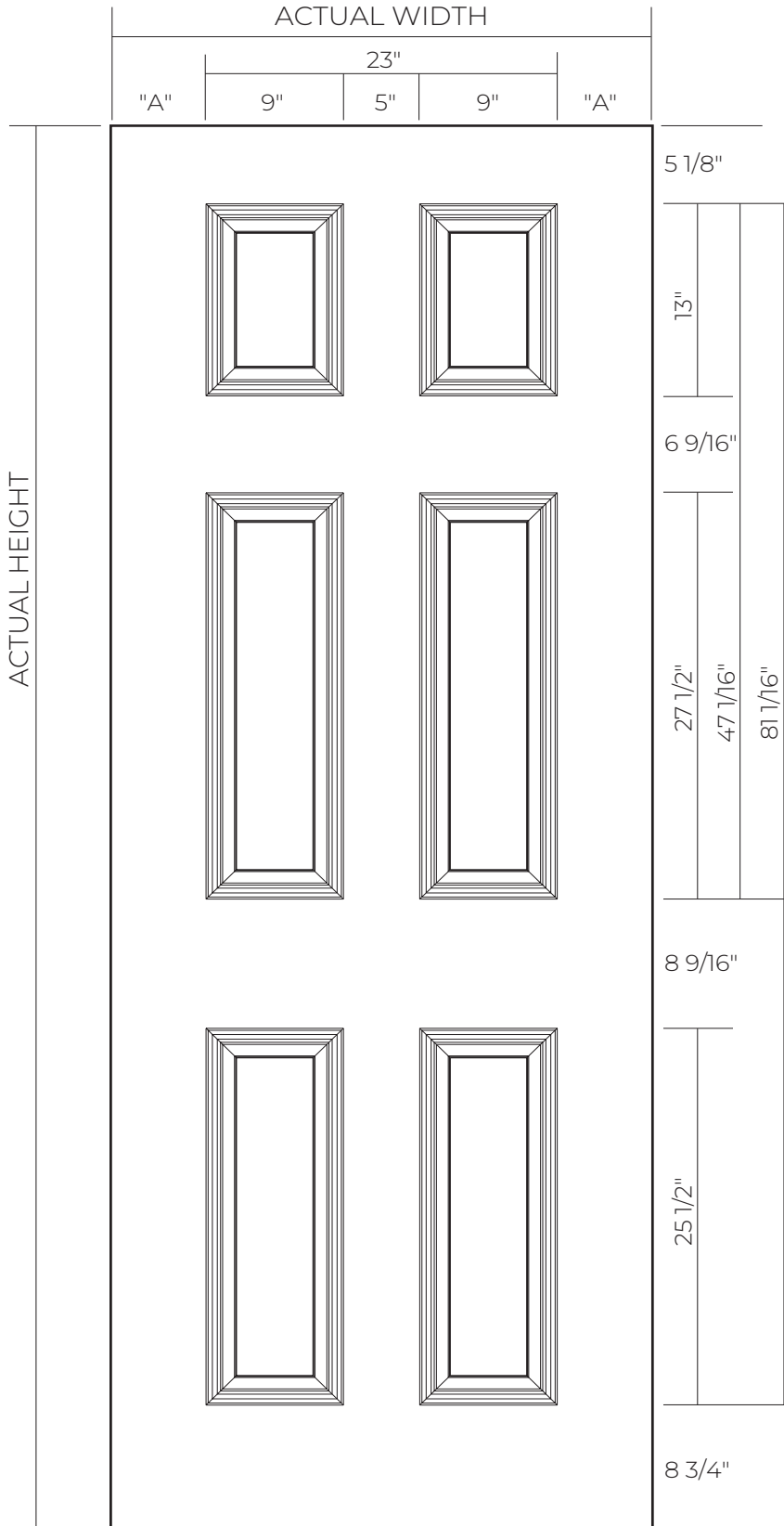

DOOR WIDTH - WOOD EDGE

NOMINAL	ACTUAL	"A"
2-8	31 3/4"	4 3/8"
2-10	33 3/4"	5 3/8"
3-0	35 3/4"	6 3/8"

DOOR HEIGHT

NOMINAL	ACTUAL	CYLINDRICAL PREP
8-0	95"	59"

GLASS OPTIONS

SIZE	CUTOUT
8 x 48	9 x 49
22 x 48	23 x 49
22 x 80	23 x 81

8'0" 2 PANEL SQUARE

STEEL DOOR

WOOD EDGE | *STEEL MARK®* & *STEEL MARK® PLUS*

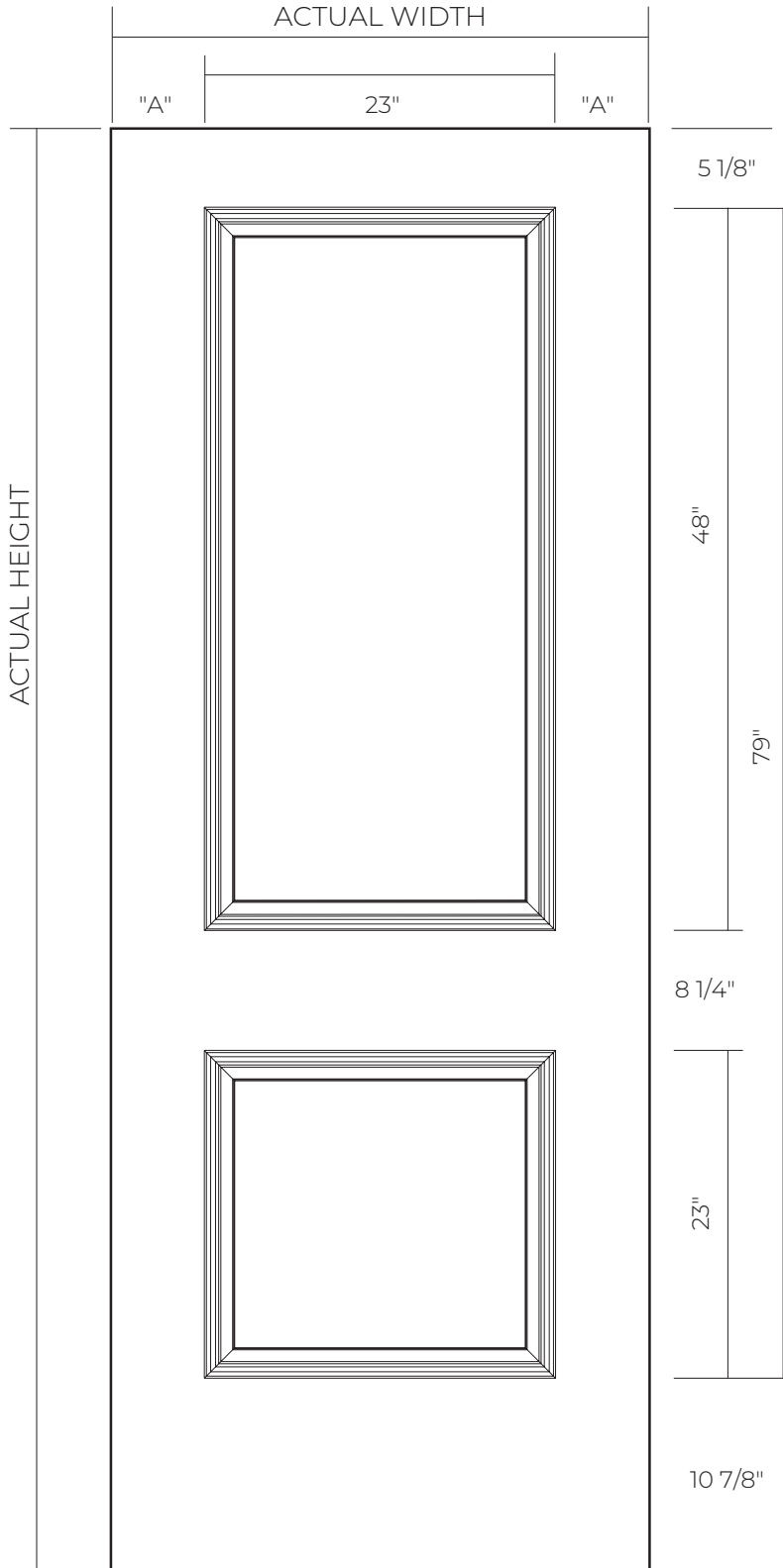

DOOR WIDTH - WOOD EDGE		
NOMINAL	ACTUAL	"A"
2-8	31 3/4"	4 3/8"
2-10	33 3/4"	5 3/8"
3-0	35 3/4"	6 3/8"

DOOR HEIGHT		
NOMINAL	ACTUAL	CYLINDRICAL PREP
8-0	95"	59"

GLASS OPTIONS	
SIZE	CUTOUT
22 x 48	23 x 49
22 x 80	23 x 81

STEEL MARK® & STEEL MARK® PLUS

8'0" EUROLINE 8

STEEL DOOR

WOOD EDGE | *STEEL MARK®* & *STEEL MARK® PLUS*

STEEL MARK® & STEEL MARK® PLUS

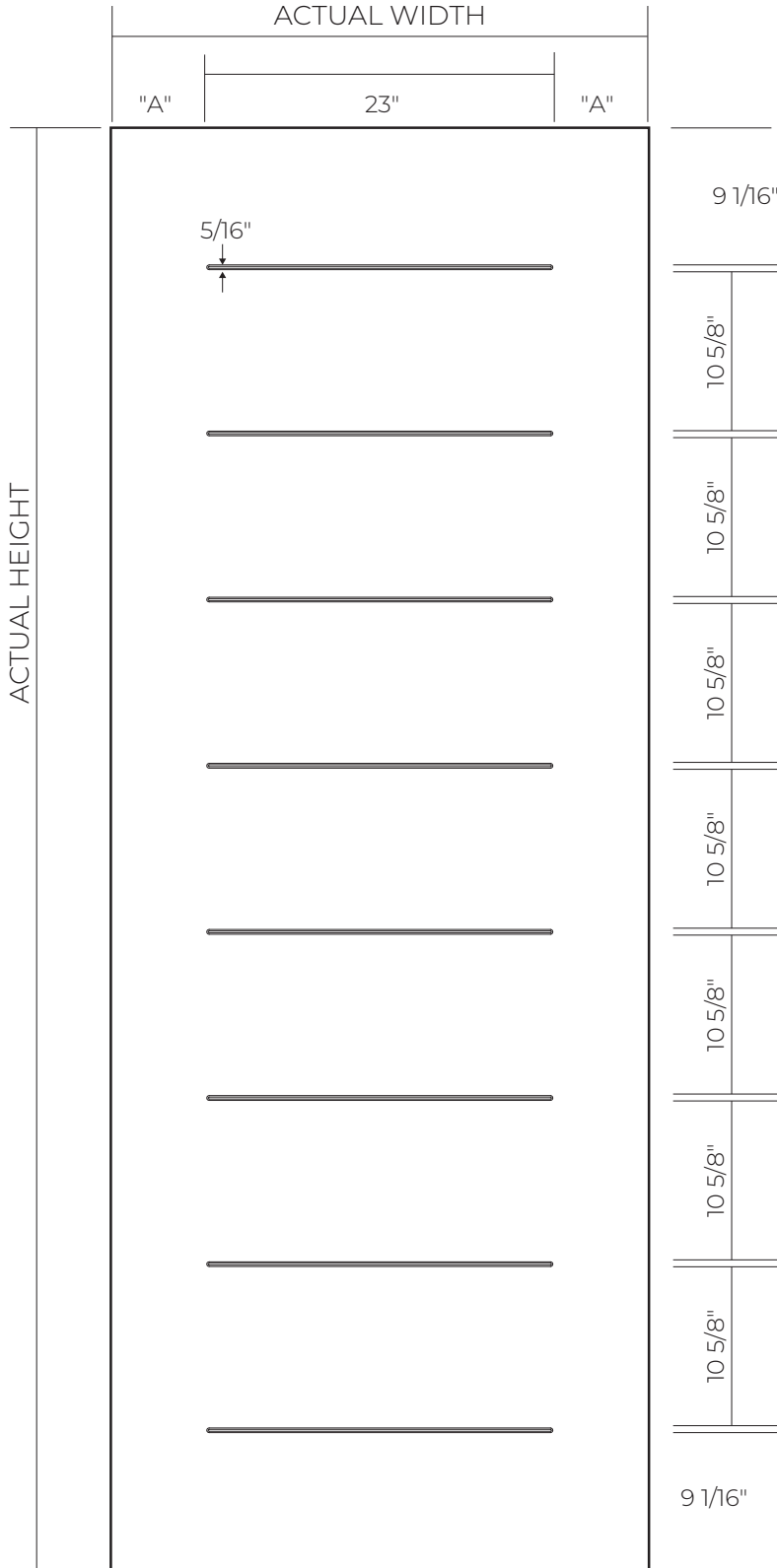

DOOR WIDTH - WOOD EDGE		
NOMINAL	ACTUAL	"A"
2-8	31 3/4"	4 3/8"
2-10	33 3/4"	5 3/8"
3-0	35 3/4"	6 3/8"

DOOR HEIGHT		
NOMINAL	ACTUAL	CYLINDRICAL PREP
8-0	95"	59"

8'0" 2 PANEL w/23x65 CUTOUT

STEEL DOOR

WOOD EDGE | **STEEL MARK®** & **STEEL MARK® PLUS**

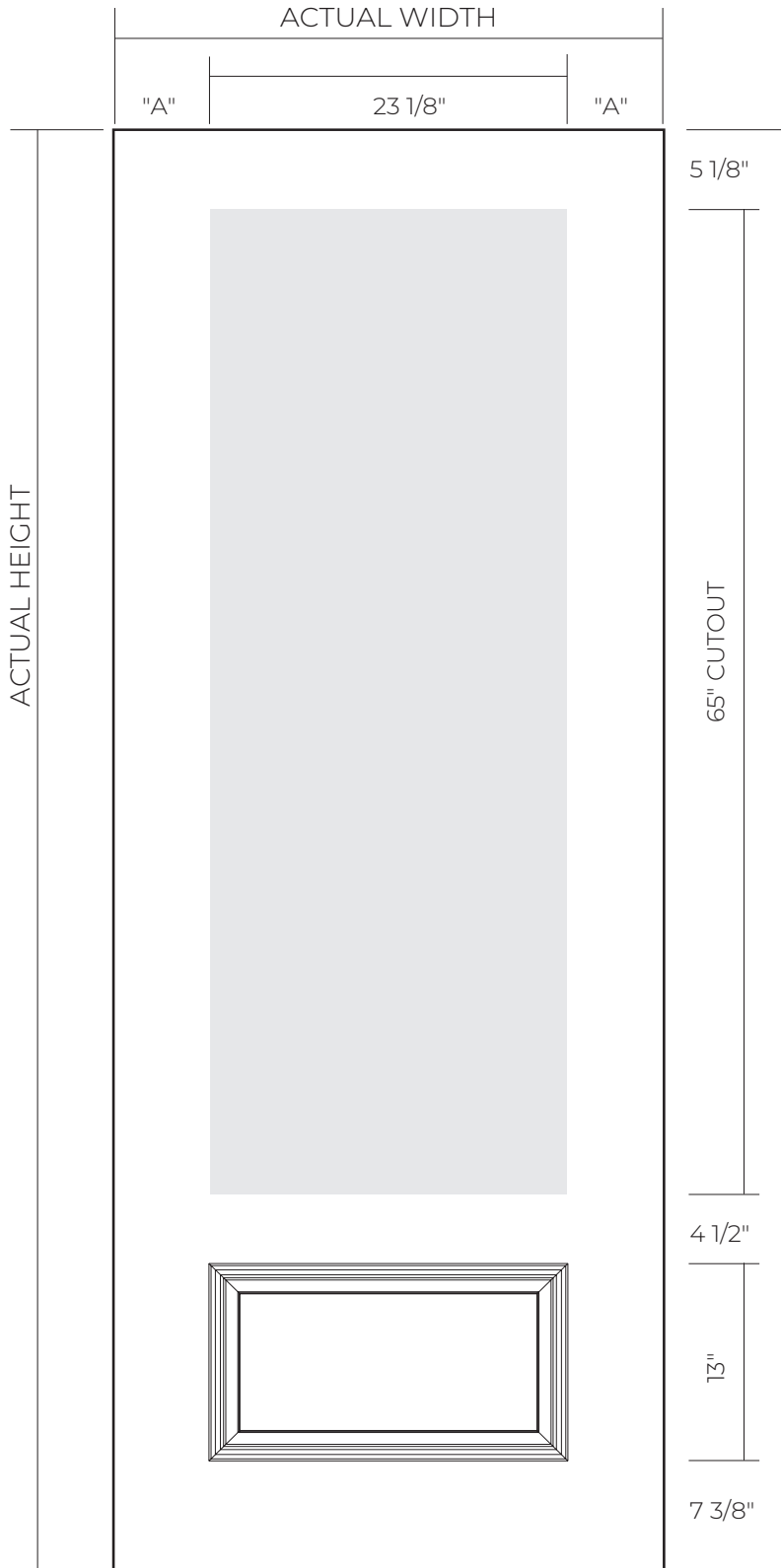

DOOR WIDTH - WOOD EDGE		
NOMINAL	ACTUAL	"A"
2-8	31 3/4"	4 5/16"
2-10	33 3/4"	5 5/16"
3-0	35 3/4"	6 5/16"

DOOR HEIGHT		
NOMINAL	ACTUAL	CYLINDRICAL PREP
8-0	95"	59"

GLASS OPTIONS	
SIZE	CUTOUT
22 x 64	23 x 65

STEEL MARK® & STEEL MARK® PLUS

8'0" FLUSH

STEEL SIDELIGHT

WOOD EDGE | **STEEL MARK®** & **STEEL MARK® PLUS**

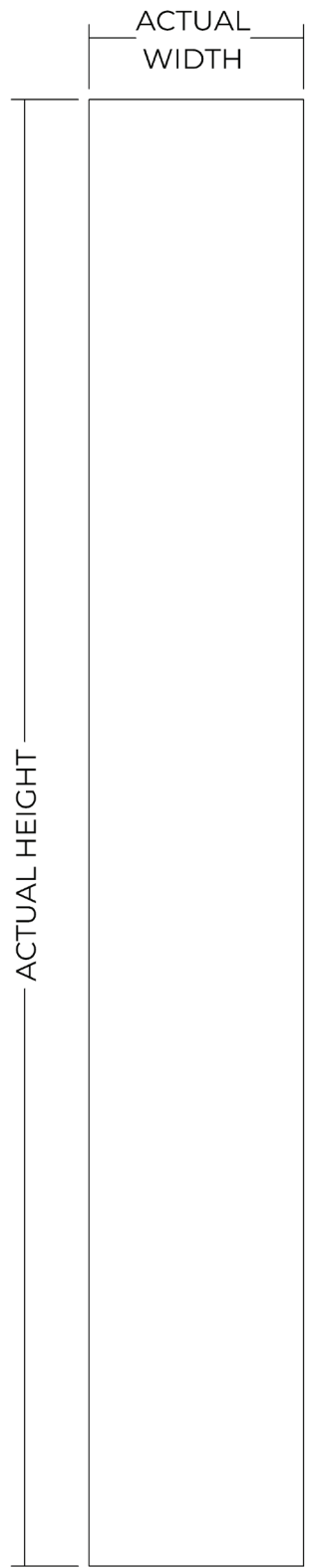

SIDELIGHT WIDTH	
NOMINAL	ACTUAL
1-0	11 7/8"
1-2	13 7/8"
1-6	17 7/8"

SIDELIGHT HEIGHT	
NOMINAL	ACTUAL
8-0	95"

GLASS OPTIONS	
SIZE	CUTOUT
8 x 80	9 x 81

STEEL PRO®

WOOD-EDGE DOORS AND SIDELIGHTS



6'8" FLUSH

STEEL DOOR

WOOD EDGE | *STEEL PRO*[®]

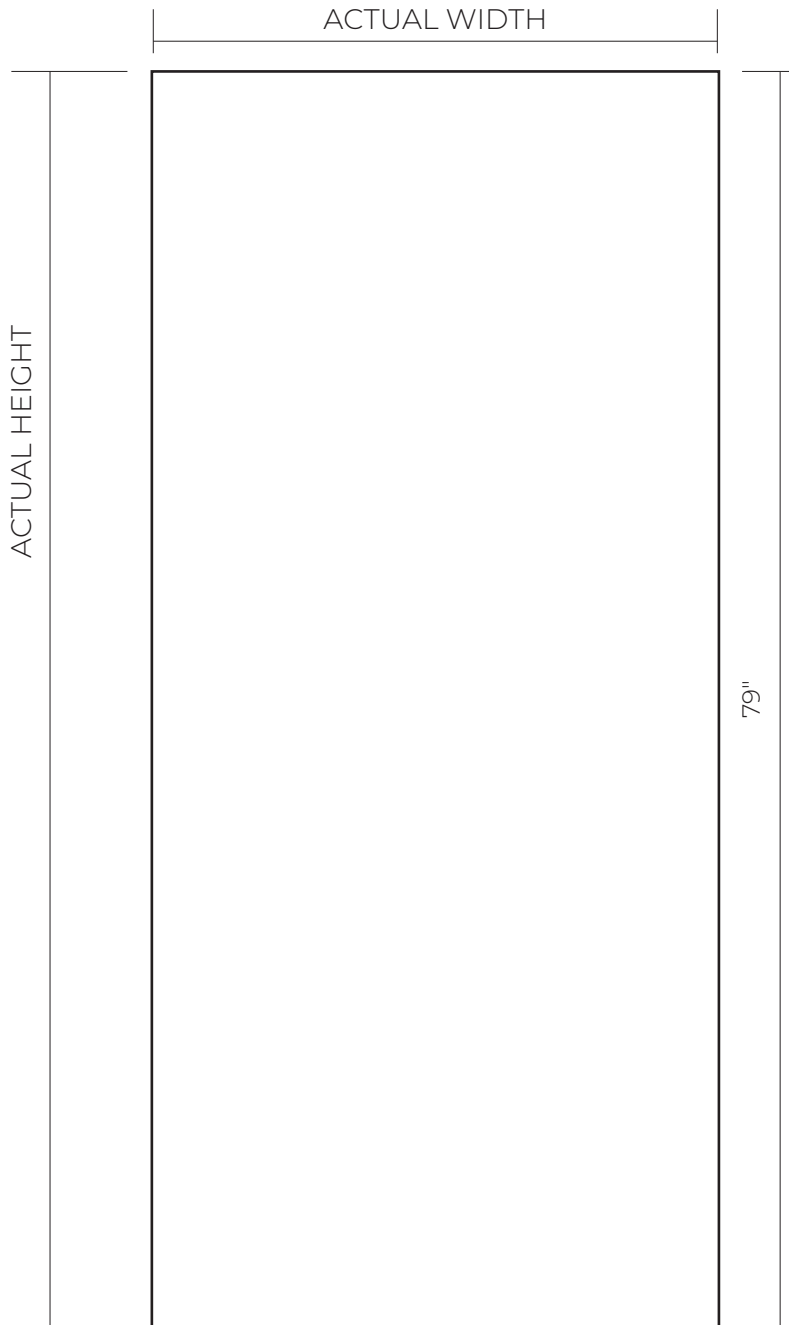

DOOR WIDTH - WOOD EDGE

NOMINAL	ACTUAL
2-6	29 3/4"
2-8	31 3/4"
2-10	33 3/4"
3-0	35 3/4"

DOOR HEIGHT

NOMINAL	ACTUAL	CYLINDRICAL PREP
6-8	79"	45 7/8"

GLASS OPTIONS

SIZE	CUTOUT
8 x 6	9 x 7
8 x 36	9 x 37
22 x 10	23 x 11
22 x 10 RT	23 x 11 RT
22 x 36	23 x 37
22 x 48	23 x 49
22 x 64	23 x 65

GARDEN DOOR SIZES AVAILABLE

STEEL PRO[®]

6'8" 6 PANEL

STEEL DOOR

WOOD EDGE | STEEL PRO®

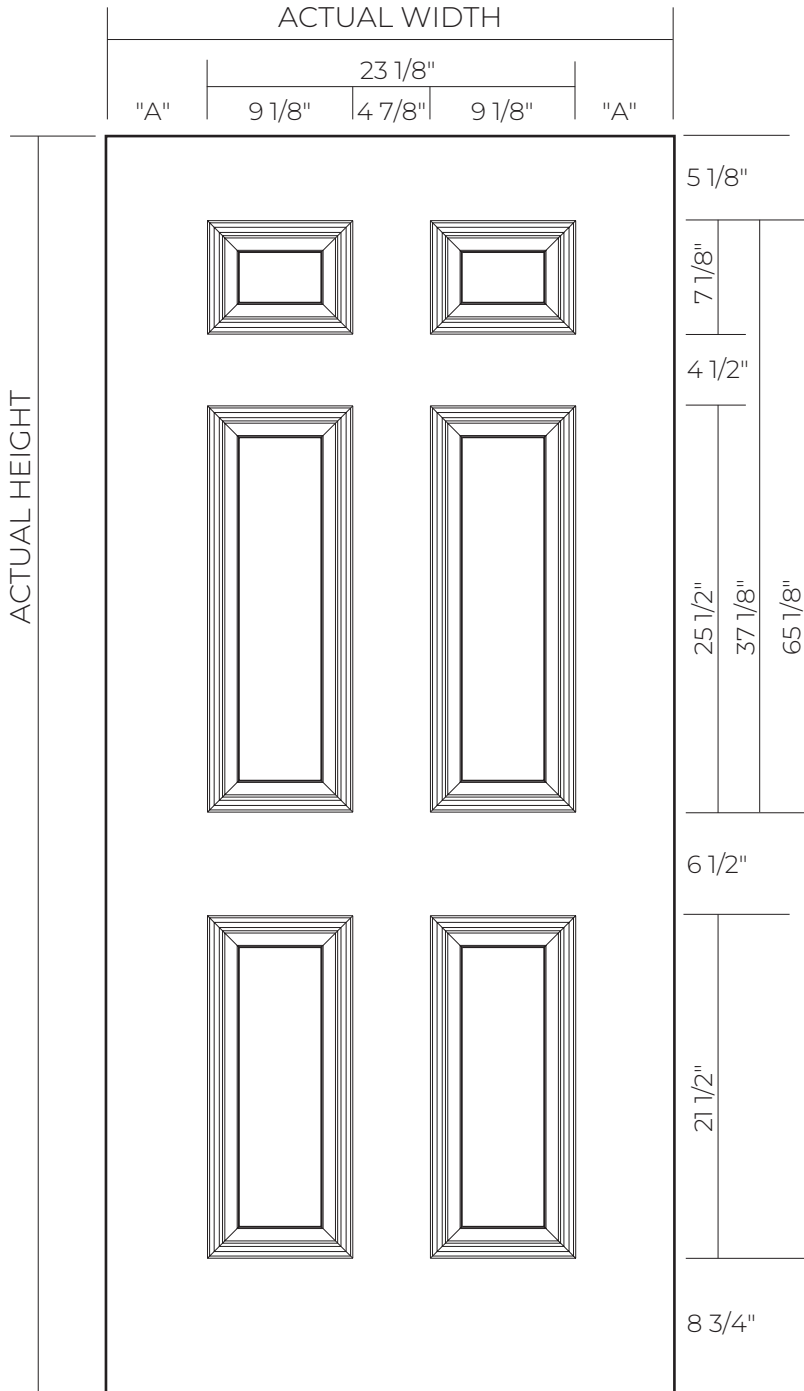

DOOR WIDTH - WOOD EDGE		
NOMINAL	ACTUAL	"A"
2-8	31 3/4"	4 5/16"
2-10	33 3/4"	5 5/16"
3-0	35 3/4"	6 5/16"

DOOR HEIGHT		
NOMINAL	ACTUAL	CYLINDRICAL PREP
6-8	79"	45 7/8"

GLASS OPTIONS	
SIZE	CUTOUT
8 x 6	9 x 7
8 x 36	9 x 37
22 x 10	23 x 11
22 x 36	23 x 37
22 x 64	23 x 65



STEEL PRO®

6'8" 4 PANEL

STEEL DOOR

WOOD EDGE | STEEL PRO®

STEEL PRO®

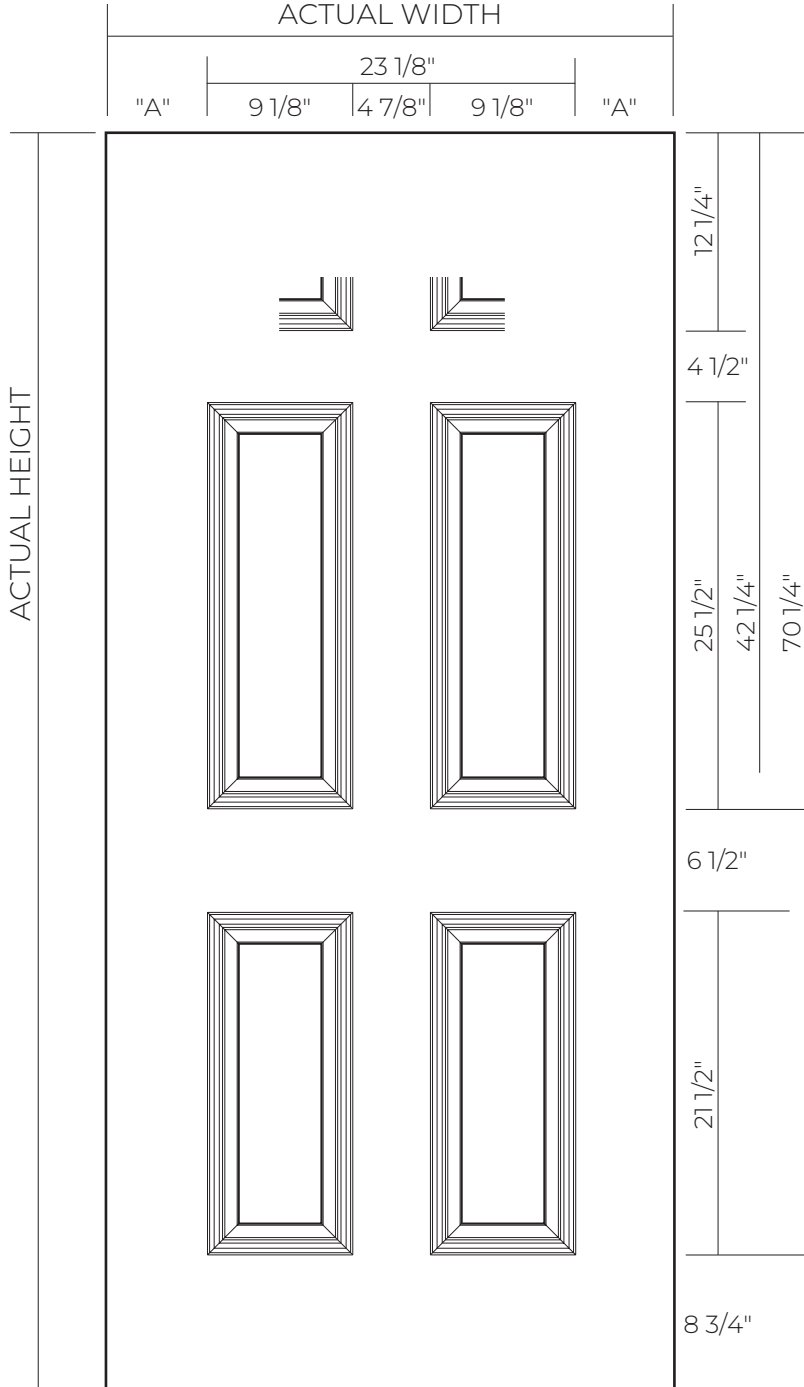

DOOR WIDTH - WOOD EDGE		
NOMINAL	ACTUAL	"A"
2-8	31 3/4"	4 5/16"
2-10	33 3/4"	5 5/16"
3-0	35 3/4"	6 5/16"

DOOR HEIGHT		
NOMINAL	ACTUAL	CYLINDRICAL PREP
6-8	79"	45 7/8"

GLASS OPTIONS	
SIZE	CUTOUT
8 x 6	9 x 7
8 x 36	9 x 37
8 x 36 RT**	9 x 37 RT
22 x 10 HR**	23 x 11 HR
22 x 36	23 x 37
22 x 64	23 x 65

* Wood Edge Only

ADDITIONAL RESOURCES

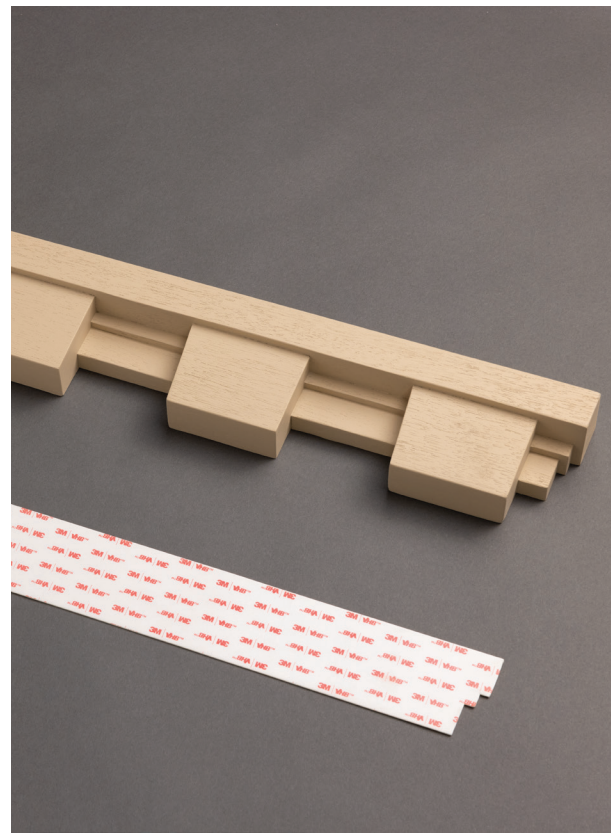

FIRE RATED OPTIONS

FIBERGLASS DOORS

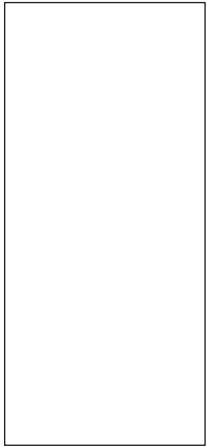

Flush

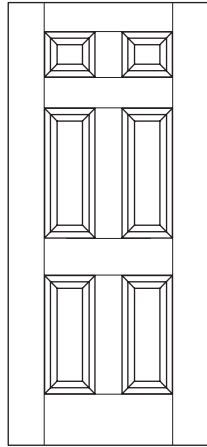

6 Panel

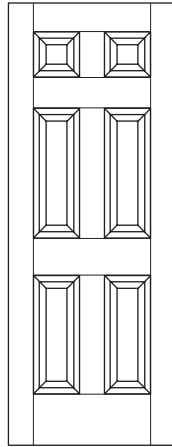

6 Panel
Narrow

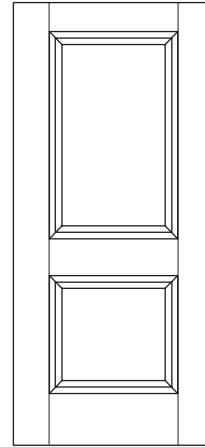

2 Panel
Square

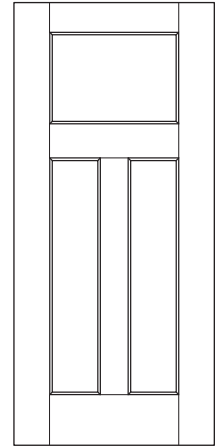

3 Panel
Craftsman

PRODUCT:

ODL Fiberglass Satin Smooth Texture Fire Rated Door.

FIRE CLASS AND FEATURED STANDARDS:

20 minute Fire Rated Category B door; UL 10C; UL 10B; NFPA 252.

FIRE RESISTANCE AND APPLICATION:

20 minute Positive Pressure without Hose Stream.

Must be installed in accordance with NFPA 80.

Category "B" Door requires a listed category "G" gasket in positive pressure applications.

Smoke and Draft door rating requires a listed category "H" gasket.

PRODUCT DESCRIPTION:

Fiberglass face, fire-resistant PU foam core door.

4" LSL stiles with maple wood caps.

Flush and embossed door designs.

20 minute mylar fire label applied or custom label for authorized customers.

SIZES:

Max size opening: 3'0" wide x 6'8" high, door thickness: 1 3/4".

LIMITATIONS:

Single units only. Approved for cylindrical latch and dead bolt—maximum 2 3/4" backset.

Permitted surface mounted listed and labeled hardware.

FIRE RATED OPTIONS

WOOD-EDGE & STEEL-EDGE STEEL DOORS

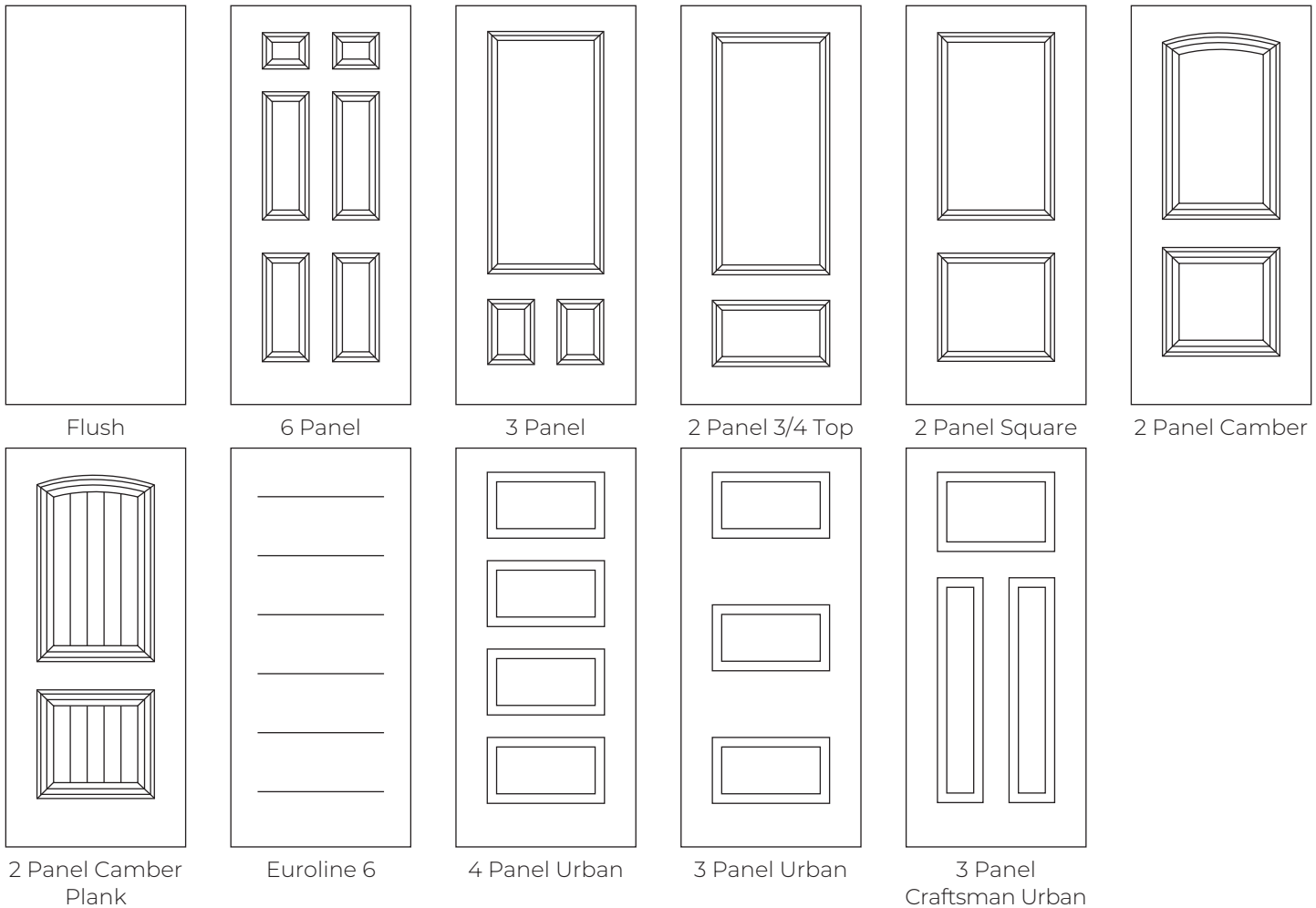

PRODUCT:

ODL Steel Mark® and Steel Mark® Plus Wood Edge and Steel Edge options with PU Foam Core.

FIRE CLASS AND FEATURED STANDARDS:

20 minute Fire Rated Category B door; UL 10C; UL 10B; NFPA 252.

FIRE RESISTANCE AND APPLICATION:

Wood Edge: 20 minute Positive Pressure with Hose Stream.

Steel Edge: 20 minute Positive Pressure without Hose Stream.

Must be installed in accordance with NFPA 80.

Category "B" Door requires a listed category "C" gasket in positive pressure applications.

Smoke and Draft door rating requires a listed category "H" gasket.

PRODUCT DESCRIPTION:

Steel skin 24ga wood edge door with PU foam core.

Steek skin 24ga steel edge door with PU foam core.

Flush and embossed door designs.

20 minute metal fire label applied or custom label for authorized customers.

SIZES:

Max size opening: 3'0" wide x 6'8" high, door thickness: 1 3/4".

LIMITATIONS:

Single units only. Approved for cylindrical latch and dead bolt—maximum 2 3/4" backset.

Permitted surface mounted listed and labeled hardware.

ADA OPTIONS

AMERICANS WITH DISABILITIES ACT
COMPLIANT FIBERGLASS DOORS

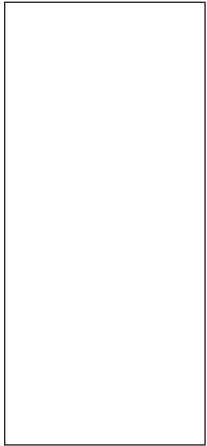

6'8"
Flush

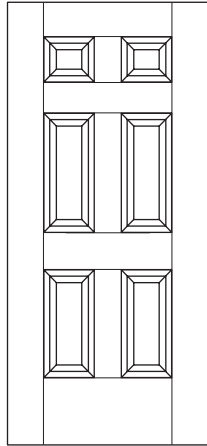

6'8"
6 Panel

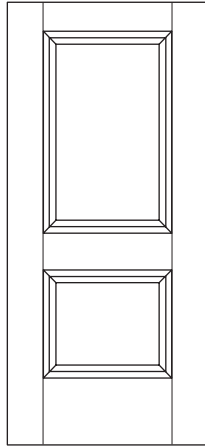

6'8"
2 Panel Square

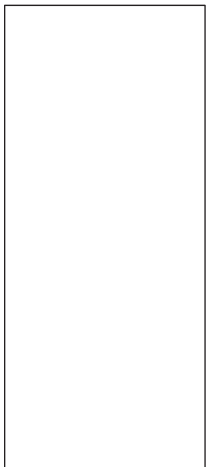

7'0"
Flush

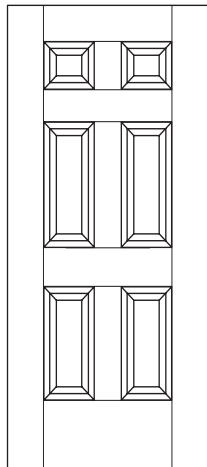

7'0"
6 Panel

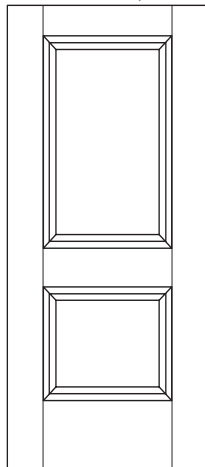

7'0"
2 Panel Square

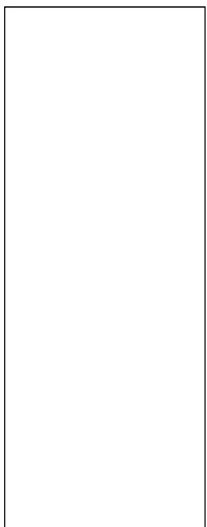

8'0"
Flush

PRODUCT:

ODL Fiberglass residential door series
ideal for multi-family applications

FEATURES AND BENEFITS:

- 10" bottom rail enables kick plate to be installed
- Pairs with ADA compliant 22x60 or 22x76 ODL doorglass sizes for Flush doors



SDL KITS

FIBERGLASS DOOR ACCESSORIES

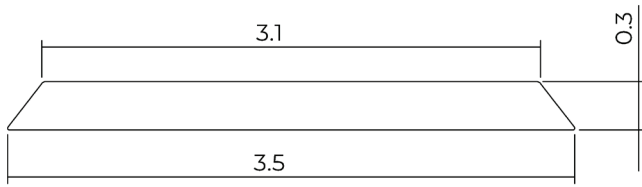

Wide 3½" SDL flat bar, comes in 25" lineals

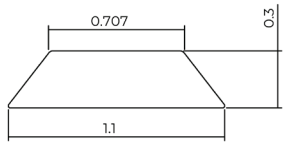

Narrow 1 ⅝" SDL bar

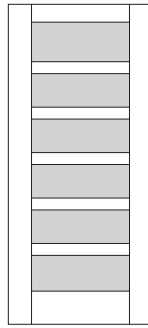

6 Light

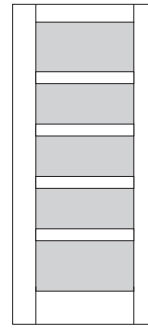

5 Light

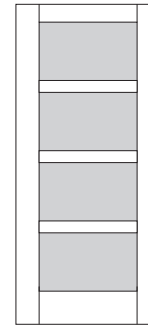

4 Light

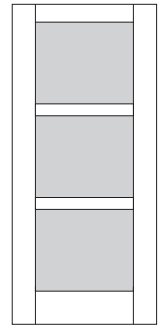

3 Light

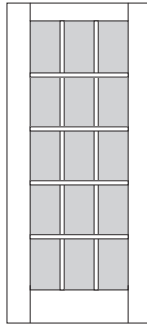

15 Light

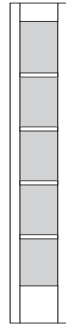

5 Light

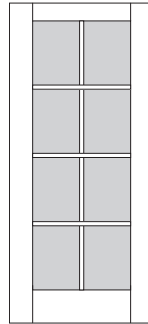

8 Light

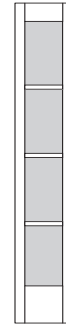

4 Light

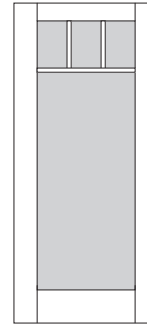

4 Light
Arts & Crafts

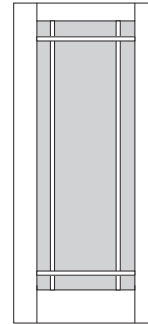

9 Light
Prairie

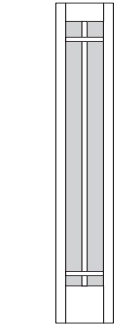

6 Light
Prairie

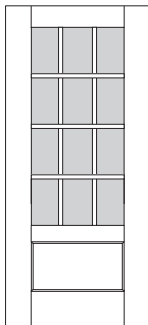

12 Light

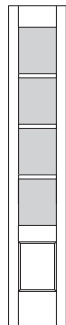

4 Light

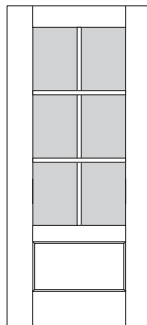

6 Light

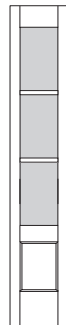

3 Light

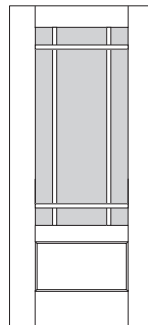

9 Light
Prairie

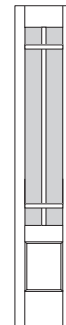

6 Light
Prairie

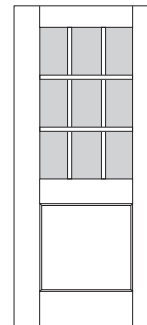

9 Light

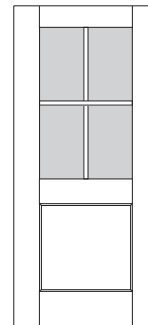

4 Light

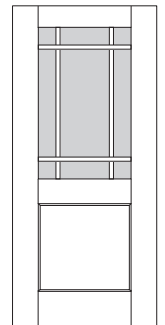

9 Light
Prairie

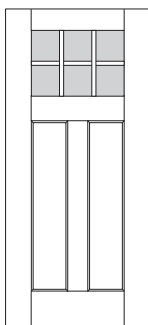

6 Light

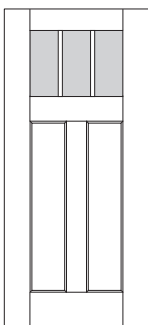

3 Light

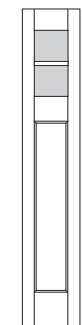

2 Light

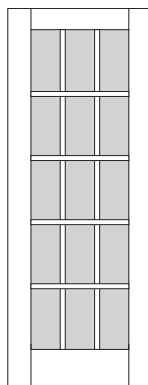

15 Light

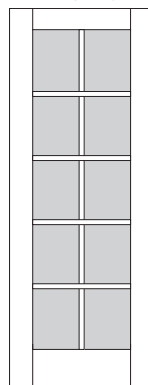

10 Light

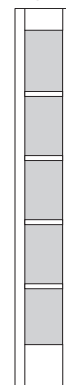

5 Light

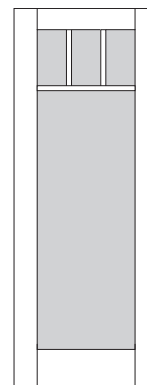

4 Light
Arts & Crafts

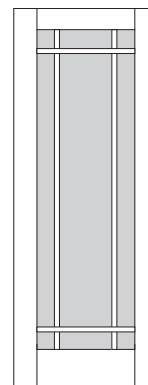

9 Light
Prairie

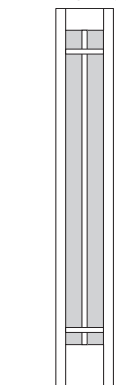

6 Light
Prairie

DENTIL SHELVES

FIBERGLASS DOOR ACCESSORIES

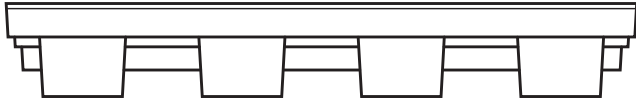

4 Block Dentil Shelf

23 1/2" x 3 1/2"

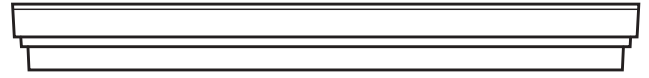

2 Tier Dentil Shelf

23 3/4" x 2 1/2"

DENTIL SHELF INSTALLATION

FIBERGLASS AND HD STEEL CRAFTSMAN DOORS

STEP 1. Lay the door on a clean, flat surface with the exterior of the door facing up.

Clean the door to remove all dirt and debris using a mild soap and water solution. Thoroughly rinse the door with clean water to remove any soap residue. Door must be completely dry prior to dentil shelf installation.

STEP 2. Before applying the adhesive tape, place the dentil shelf at the desired location on the door panel. The shelf should be centered on the width of the door and parallel to the glass opening. The shelf should also be centered between the glass opening (flush glazed doors), or doorglass frame and the vertical embossments on the panel. Once located, lightly mark the position on the door with a graphite pencil along the top and sides of the shelf.

See Fig. 1.

STEP 3. Lightly sand ONLY the backside of the dentil shelf where the adhesive strip will be applied. Ensure the surface is dry and free of all dust, dirt, and debris. Without removing the adhesive liner place the adhesive strip against the shelf to determine correct fit. Any protruding portions of the adhesive strip should be trimmed prior to installation.

STEP 4. Remove the protective liner on one side only of the adhesive strip and carefully align the adhesive strip with the dentil shelf. Ensure good contact of the adhesive strip and the dentil shelf by applying pressure.

STEP 5. Remove the other side of the protective liner and using the pencil marks, locate the shelf on the door panel. Apply firm pressure to the dentil shelf to ensure proper adhesion.

See Fig. 2.

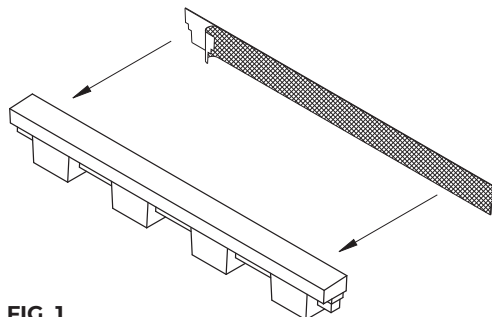

FIG. 1

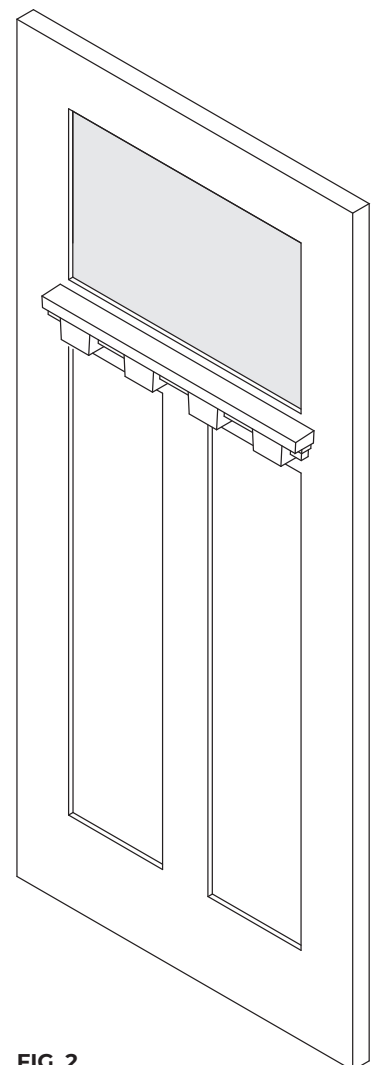

FIG. 2

CLEANING & FINISHING INSTRUCTIONS

FIBERGLASS DOORS

CLEANING

Clean the door with a clean, lint-free cloth, removing all dust and foreign debris. For light cleaning, a one part vinegar to ten parts water mixture can be used. For tough dirt removal, use denatured alcohol or mineral spirits making sure all residue is removed by turning the cloth often while cleaning. Allow the door to dry thoroughly. DO NOT USE SANDPAPER OR LACQUER THINNER AS IT MAY DAMAGE THE FIBERGLASS SURFACE.

PAINTING

Clean the door as outlined in the cleaning section. Wipe dry with a clean cloth before the denatured alcohol or mineral spirits dries. Be sure surface is completely clean and dry before proceeding.

It is recommended that you use high quality exterior grade acrylic latex products to paint your door. Apply paint only when both air and door temperatures are above 50° F. Paint can be spray applied, brushed or roll applied. Spray application is recommended for large surface areas to achieve optimum appearance. Be sure to paint all six sides of the door. If glass is installed in the door, follow painting instructions for the doorglass frame provided. Allow to completely dry before installing any hardware.

STAINING

Clean the door as outlined in the cleaning section. Wipe dry with a clean cloth before the denatured alcohol or mineral spirits dries. Be sure surface is completely clean and dry before proceeding.

Apply an even amount of good quality exterior solvent-based stain, or a gel stain recommended for fiberglass doors. For best results, apply stain with a foam brush or lint free cloth, one section of the door at a time, starting with the embossed panels first and then the flat sections.

Work the stain into the grain using a circular motion. Before stain dries completely, wipe the surface in the direction of the grain with a clean cheesecloth or rag to remove any excess stain. Tip: Use a dry, soft china bristle brush to feather out lap marks and to blend the stain. Remove any excess stain on the brush by wiping on a dry cloth. Then feather the stain until desired color is reached.

If a darker appearance is desired, apply a second coat after the first coat dries. Follow the stain manufacturer's instructions to apply and wipe the stain with a brush or rag. Repeat the staining process on the remaining unstained sides of the door after one side is stained and has completely dried.

Allow stain to dry per manufacturer's recommendations (may take up to 48 hours). Spray on at least one coat of clear exterior grade polyurethane with UV inhibitors. THE FIRST COAT MUST BE SPRAYED ON. Additional coats may be sprayed or brushed on. Repeat process on the remaining unfinished sides of the door. Allow to completely dry before installing any hardware.

CLEANING & FINISHING INSTRUCTIONS

STEEL DOORS

CLEANING

In most cases, simply washing the door with plain water using a garden hose or pressure spray will be adequate. However, in areas where dirt collection is heavier or mildew has occurred, the following solution is recommended to remove these build-ups:

- 1/3 cup dry powered detergent (such as Tide®)
- 2/3 cup trisodium phosphate (such as Soilax®)
- 1 quart sodium hypochlorite 5% solution (such as Clorox®)
- 3 quarts water

Note: It is advisable to use rubber gloves when handling this solution.

A stiff bristle brush may be useful for an embossed door. To minimize streaking, always wash from the bottom to the top. A clean water rinse should follow immediately.

Strong solvents and abrasive type cleaners should be avoided to prevent any permanent damage to the finish. Remove caulk compounds, oil, grease, tars, wax and similar substances with mineral spirits only to those affected areas.

Follow with detergent cleaning and clear water rinsing. Be sure to rinse thoroughly.

PAINTING

Clean the door as outlined in the cleaning section. Wipe dry with a clean cloth before the mineral spirits dries. Detergent cleaning is not necessary at this point.

To achieve maximum paint adhesion, you should lightly scuff the door with 400 grit sandpaper or fine steel wool. Be sure to remove dust particulate by wiping with a damp cloth. Allow to dry completely.

It is recommended that you use high quality acrylic latex products to paint your door. Apply paint only when both air and door temperatures are above 50° F. Paint can be spray applied, brushed or roll applied. Spray application is recommended for large surface areas to achieve optimum appearance.

ADJUSTABLE HINGE INSTRUCTIONS

STEEL EDGE DOORS

TOOLS AND MATERIALS NEEDED

- Pencil
- Phillips Head Screwdriver
- Pry Bar
- Measuring Tape
- Safety Glasses

STEP 1. ADD REFERENCE MARKS

Determine proper fit and use a pencil to make reference marks between the door and top and side of hinge. See Fig. 1.



FIG. 1

STEP 2. LOOSEN HINGE SCREWS

Loosen hinge screws using a Phillips head screwdriver (**do not completely remove screws**).

STEP 3. BREAK TEMPORARY BOND

The door is prepped for hinges using factory preset locations that are temporarily bonded in place place.

To adjust your door it is necessary to break the temporary bond by using a pry bar at the bottom **hinge side** of the door. Apply force upwards. Use caution to avoid damage to the door sweep. Once the bond is broken the hinge reinforcement plates in the door will move freely. See Fig. 2.



FIG. 2

FACTORY PRESET



FIG. 3

UP ADJUSTMENT



FIG. 4

DOWN ADJUSTMENT



FIG. 5

IN ADJUSTMENT



FIG. 6

OUT ADJUSTMENT

STEP 4. ADJUSTMENT DETAILS

The door can be vertically adjusted 5/8" and 1/8" in or out.

STEP 5. UP/DOWN ADJUSTMENTS

To adjust up or down use the pry bar to lift the door to desired height then tighten the screws on all three hinges. See Fig. 3 & 4.

STEP 6. TOP IN/OUT ADJUSTMENTS

For top in/out adjustment, use the pry bar to lift the door to desired height then tighten all screws on the bottom hinge. Adjust door in/out as needed then tighten screws on remaining hinges. See Fig. 5 & 6.

STEP 7. BOTTOM IN/OUT ADJUSTMENTS

For bottom in/out adjustment, use the pry bar to lift the door to desired height then tighten all screws on the top hinge. Adjust door in/out as needed then tighten screws on remaining hinges. See Fig. 5 & 6.

STEP 8. FINAL STEP

When complete, double check that all hinge screws are sufficiently secure.



215 E ROOSEVELT AVE. ZEELAND, MI 49464

800.253.3900 ODL.COM

©ODL, INC. All rights reserved

